

October 2016



DMfit®



DM DMT
www.dmfit.com



DMfit®

PUSH-IN TUBE FITTINGS



WRAS approval :

DMfit® complies with WRAS requirements of the United Kingdom Water Regulations.



US FDA approved materials :

DMfit® fittings are produced using FDA approved materials.



SK Zert, ANSI/NSF-51, 61 Certifications :

DMfit® fittings are suitable for contact with foodstuffs & drinking water.



ISO 9001/ISO14001 Certifications :

DMfit® fittings are produced under a registered ISO 9001 / ISO 14001 quality system.

ISO 9001 ISO 14001



Unsere DMfit® Fittings erfüllen die KTW-Leitlinie des deutschen Umweltbundesamtes.

Since our creation in 1987, we have taken a leading position in the plastic extruded casing industry because of our quality-first mindset, integrity and technical leadership.

Now, we have made a second bold leap - into the fittings business. The goal is to be a global leader, providing the best net value in fittings products to the entire range of fluid handling industries.



CONTENTS

TECHNICAL INFORMATION

Terms and Conditions	5
General Specifications	6

INCH SIZE PRODUCTS

Acetal Fittings (Gray)	8
Acetal Fittings (White)	14

METRIC SIZE PRODUCTS

Acetal Fittings (Black)	19
-------------------------------	----

POWER PRODUCTS

Acetal Power Fittings(Inch/Metric)	26
Clean Fittings	28

P-P PRODUCTS

Polypropylene Fittings	29
------------------------------	----

VALVE PRODUCTS

Stop & Faucet Adaptor Valves	34
Control Valves	36
Hand Valves	38
Check Valves	41
Stop Valves	42

OTHERS

Filter Strainers	43
Brass Fitting(Inch/Metric)	44
Cartridges	45
Full Cartridges	47
Accessories	48
LLDPE TUBES	50
Chemical Compatability	51



PUSH-IN TUBE FITTINGS

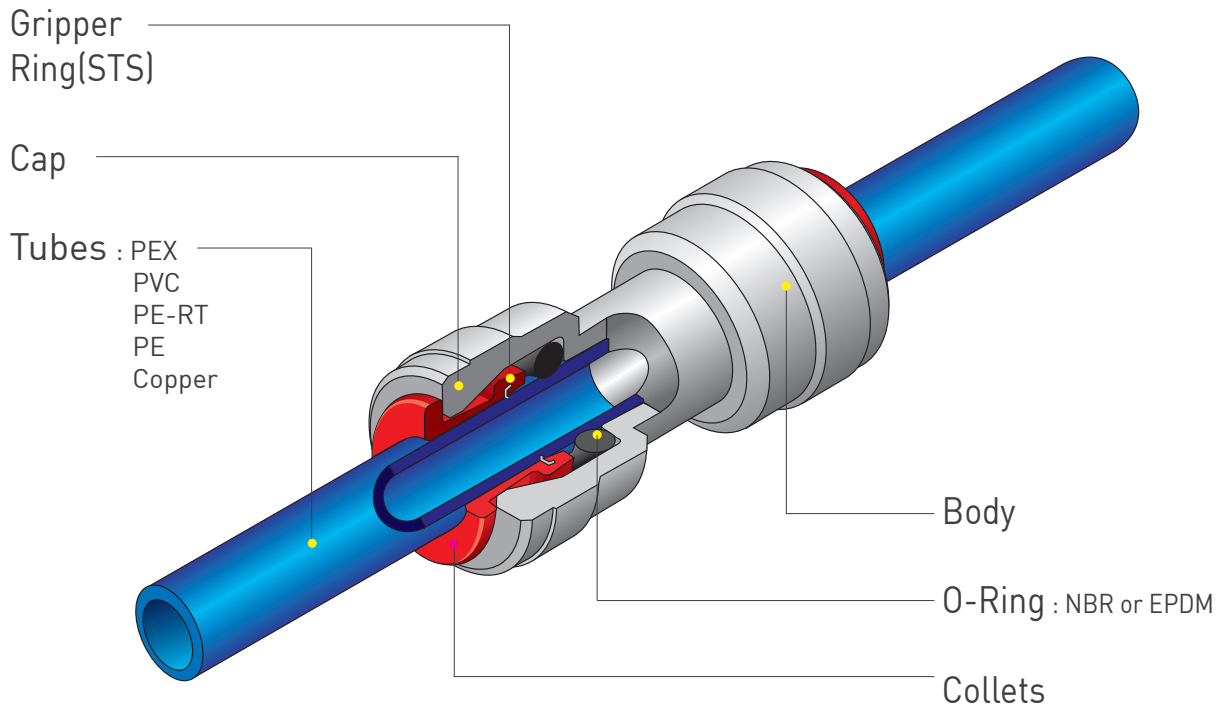

Material Standards

Material Options	Fittings Color	O-ring
A - acetal	Gray, Black, White	NBR / EPDM
P - polypropylene	White	
B - brass	brass, or chromed	

Outer Diameter Tolerance Limit of Tubing Used with Fittings

	Size	Tolerance
Small Size	5/32", 4mm	±0.004" (±0.1mm)
	3/16", 5mm	
	1/4", 6mm	
	5/16", 8mm	
	3/8", 10mm	
Large Size	1/2", 12mm	±0.004" (±0.1mm)
	5/8", 15(16)mm	
	7/8", 18(22)mm	
	28mm	

※ For use at higher temperatures or pressures, please contact your DMfit representative for assistance.

Fitting Working Pressure and Temperature

Temperature	SIZE	Small Size					Large Size					
		5/32" 4mm	3/16" 5mm	1/4" 6mm	5/16" 8mm	3/8" 10mm	1/2" 12mm	5/8" 15mm	7/8" 18mm	28mm		
1°C (34°F)		16bar (230PSI)					11bar (170PSI)	11bar (170PSI)				
20°C (68°F)		16bar (230PSI)					11bar (170PSI)	11bar (170PSI)				
65°C (150°F)		10bar (150PSI)					7bar (100PSI)	7bar (100PSI)				

Maximum Permissible Torque

		Thread		1/8", 1/4"		3/8", 1/2"		3/4"
Torque								
		Plastic	Maximum Torque	(Nm)	1.5		3.0	
Steel	Maximum Torque	(Nm)	7.0-9.0	12.0-14.0	22.0-24.0	28.0-30.0	40.0	

※ The above values are average maximum applied torque. Actual results may vary.

Installing DMfit Fittings

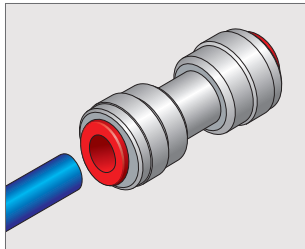

- Cut the part of the tube to be inserted into the fitting to plane the end.
- Make sure to use a clean tube without any foreign material or cracks.

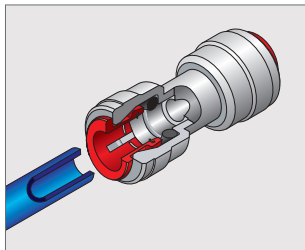

- When inserting the tube, remove any obstructions before fully inserting the tube. Make sure the tube is fully inserted.
- Inserting the tube into the fitting only takes moderate force. The tube or fitting should not be scratched or damaged in the process, as this is the main cause for water leaks later on.

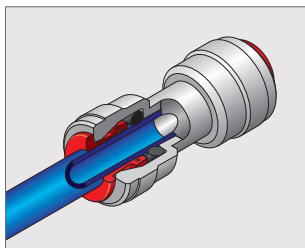

- To make sure that the fitting is properly connected to the tube, pull it once. After pulling, insert a spanner under the collet and push the tube into the fitting once more for a complete insertion.

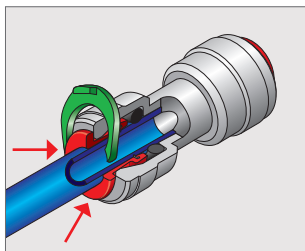

- When no play is desired for the fitting and tube, use our company's LC to eliminate the play of the fitting.

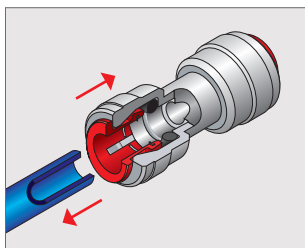

- Make sure to completely eliminate pressure before disassembling the fitting.
- When disassembling the tube, push the clip in direction of the main assembly and then pull the tube out for easy disassembling.
- Fittings and tubes can be reused.

Terms and Conditions

Please read, understand, and follow all instructions, precautions, and warnings prior to using Dmfit® products on pressurized systems. Failure to follow all instructions, precautions, and warnings may result in bodily harm or property damage.

⚠ Warnings and Precautions

- ① Fittings are not recommended for use with liquids other than water and food or beverage products. Where fittings may be used with other chemicals contact DMT for advice.
- ② Do not disassemble or modify the individual product, as this may cause a product malfunction, leak, or failure and voids the product warranty.
- ③ Do not over-stress the fitting by rotation, twist, bending, shock, fatigue, or other excess force. This may damage the fitting and cause malfunction, leak, or failure and voids the product warranty.
- ④ Do not use the product where ambient temperature or fluid temperature may exceed 65°C (150°F) in domestic environment Food & Drink, Industrial Pneumatic. This may damage the fitting and cause malfunction, leak, or failure.
- ⑤ Do not use pipe dope or other liquid thread sealers. Use only Teflon tape to seal threaded connections.
- ⑥ If your plumbed line is used as an electrical ground, you must use a jumper wire to provide continuity across plastic fittings and tubing.
- ⑦ Never press collets toward the body unless attempting to separate tubing from a fitting in an unpressurized line. The use of the DMfit® Locking Clip is advised to restrict inadvertent disassembly of connections.
- ⑧ DMT reserves the right to modify the product from time-to-time as required for quality improvement and per market requirements. Actual product may differ from pictures shown.
- ⑨ Connecting DMfit® products to tubing or connecting elements other than DMfit® products is not warranted for performance. Always perform any checks and testing necessary to verify acceptable function.
- ⑩ Before making any tube connection, verify that the end of the tube has been cut square and there are no scratches on the tube O.D within 30mm of the end.
- ⑪ When making a tube connection, occasionally a gripping of the tube may occur just as the tube begins to pass through the o-ring, although the seal is not yet made. In this case, push the tube deeply once more to complete assembly of the connection. Failure to completely seat the tube into the fitting may cause a leak.
- ⑫ When using metallic tubing, de-burr the tube ends to avoid potential cutting or other damage to the o-ring.
- ⑬ After assembling a tube connection, tug with moderate force to check for proper gripping of the tube.
- ⑭ Before disassembling tube connections, always verify that pressure has been removed from the system.
- ⑮ When disassembling tube connections, always press the collet evenly toward the body and then pull the tube. If a locking clip is used, remove the locking clip before attempting to separate a tube connection.
- ⑯ When tightening threaded fittings, use care not to over-torque the fitting as this may damage the fitting and cause a leak or other failure.
- ⑰ TS (Tube Support) supports to soft tube and tube at 65°C (150°F) of ambient and fluid temperature.
- ⑱ Our threaded fittings should be complied with our specification. (ref. page4)

Material Characteristics

- **Acetal** : Also known as POM. Highly durable and resistant to fatigue and creep. It has high resistance to a wide range of organic & inorganic chemicals and detergents. Not recommended for use with strong acids or repeated exposure to strong oxidizers.
- **Polypropylene** : Has excellent chemical resistance, cold endurance, and high tolerance to oxidizers.

PUSH-IN TUBE FITTINGS

Poor DSI assembly

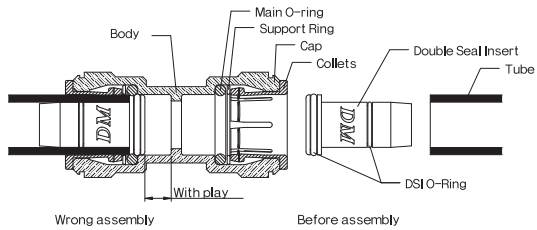

Good DSI assembly

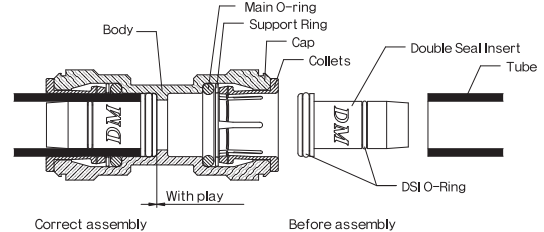

Three way valve to control direction of water flow.

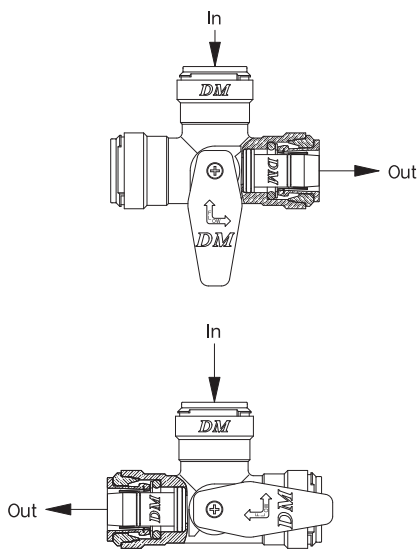

Example of tank connector assembly

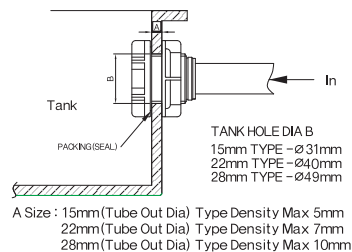

Checking force of a double check valve

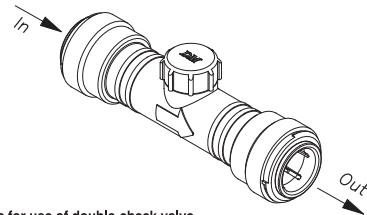

- ※ Notice for use of double-check valve
- In case of reverse pressure, the valve will withstand temporary pressure spikes of up to 10bar.

Hand valve connector

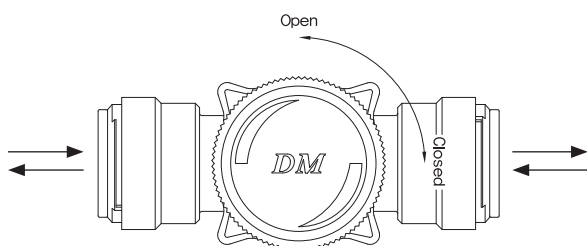

Hose cutter

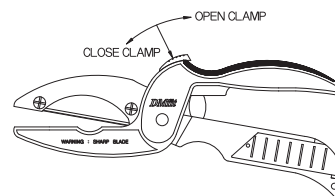

- ※ Notice for using the hose cutter
1. Be careful when using the cutter, as the blade is very sharp.
 2. When the cutter is not in use, put it in "lock" position.

Example of Hand Wash Machine assembly

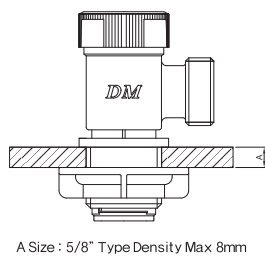

Example of Hand Valve Female Adapter assembly

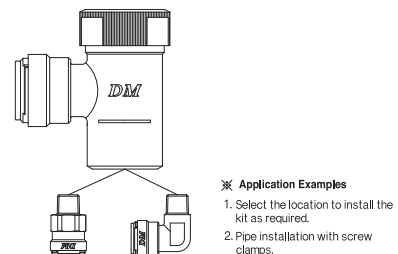

Usage and Features I

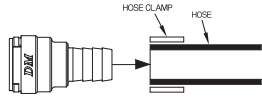

※ Application Examples

1. Use connected with a hose.
2. Fix the hose clamp to make sure the connector does not disengage from the hose.
3. When connecting braided hoses, use a pressed metal connector on the connecting end.

Usage and Features II

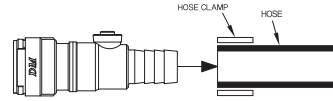

※ Application Examples

1. Use connected with a hose.
2. Fix the hose clamp to make sure the connector does not disengage from the hose.
3. When connecting braided hoses, use a pressed metal connector on the connecting end.
4. Water flow can be blocked with the stop valve.

THC-Throttle Hand Valve Connector

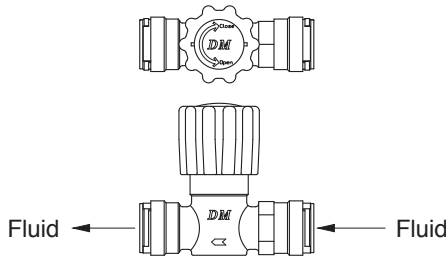

FWC-Four Way Connector

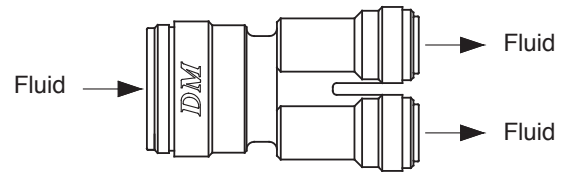

HSV-Hand Stop Valve

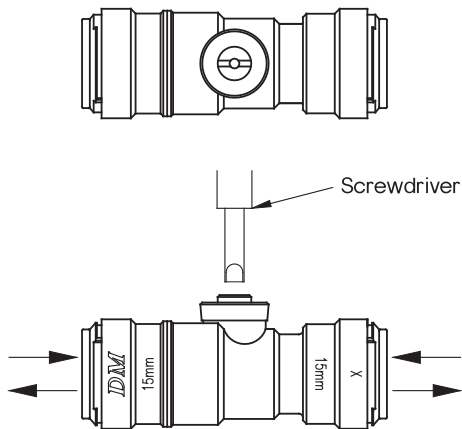

DMfit Fitting Standard Anatomy

● All diagrams are based on the UC0808 product.

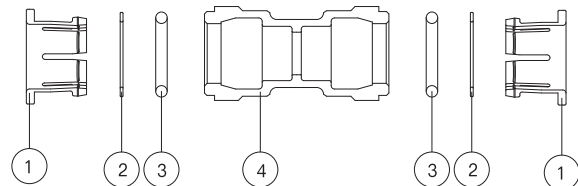

No.	Part Name	Material	Q'ty	Remark
1	Collets	Acetal	2	
2	Support Ring	Acetal	2	
3	O-ring	NBR	2	
4	Body	Acetal	1	

■ Exceptional, Small sizes don't have Sup-Ring in the body.

Flow Bend Clamp Assembly and Application Features

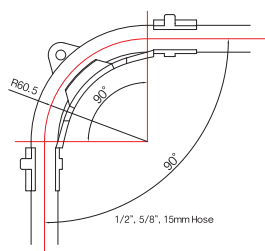

How to Connect the Locking Tube Locking

5/8", 15mm 16mm Hose

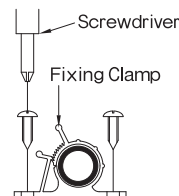

※ Application Examples

1. Use connected with a hose.
2. Fix the hose using the fixing clamp. Use screw to attach the product to a wall.

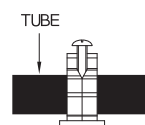

ACETAL FITTINGS (GRAY / INCH)



■ Suitable for

- **Water & foods use :** *DMfit*® products are manufactured from safe, non-toxic materials meeting the requirements of the US FDA, WRAS, ANSI/NSF-51, 61, and SK Zert. Our products are widely used in water purification, food/beverage and pneumatic systems.
- **Function & Quality :** *DMfit*® provides quick and convenient assembly - saving time & expense. Our ISO9001, 14001 registered quality system ensures our customers a superior level of product quality. Defects are easily detectable and maintenance is easy with its easy dismantling for access.
- **Collet Design :** Our unique oval collet design is superior and more practical, and is an improvement welcomed by our world-wide customers in all industries.
- **Applications :** Beyond water and food use, fittings can be used with air, gases, vacuum, & liquids. And all connections can be assembled & disassembled repeatedly. A broad of sizes covers a broad scope of applications.
- **Color :** Gray Acetal Copolymer

Part Numbering System

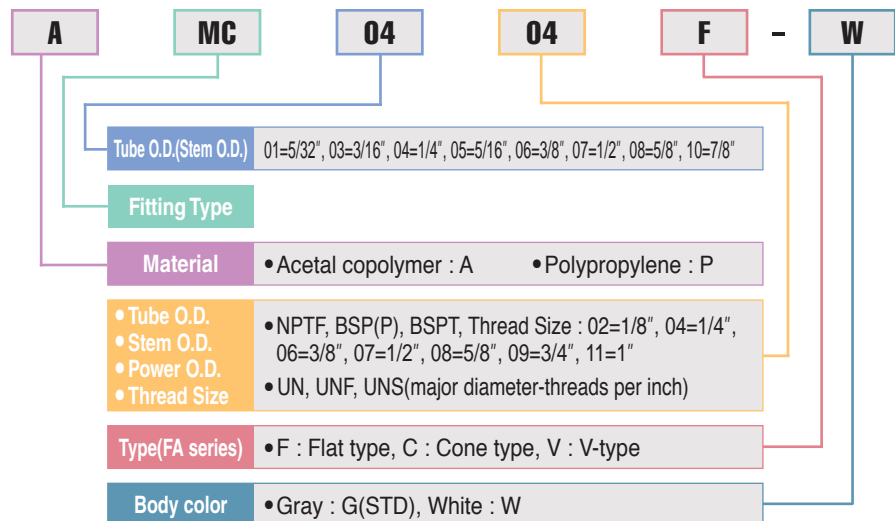

MC - Male Connector



NPTF Thread

PART NO.	Tube O.D.	NPTF Thread	Qty / Box
AMC 0102	5/32	1/8	500
AMC 0104	5/32	1/4	500
AMC 0302	3/16	1/8	500
AMC 0402	1/4	1/8	400
AMC 0404	1/4	1/4	350
AMC 0406	1/4	3/8	300
AMC 0407	1/4	1/2	150
AMC 0502	5/16	1/8	400
AMC 0504	5/16	1/4	400
AMC 0506	5/16	3/8	350
AMC 0602	3/8	1/8	300
AMC 0604	3/8	1/4	300
AMC 0606	3/8	3/8	250
AMC 0607	3/8	1/2	200
AMC 0706	1/2	3/8	200
AMC 0707	1/2	1/2	150

MCB - Male Connector



BSP(P) Thread

PART NO.	Tube O.D.	BSP(P) Thread	Qty / Box
AMCB 0102	5/32	1/8	500
AMCB 0104	5/32	1/4	500
AMCB 0302	3/16	1/8	500
AMCB 0304	3/16	1/4	400
AMCB 0402	1/4	1/8	400
AMCB 0404	1/4	1/4	400
AMCB 0502	5/16	1/8	400
AMCB 0504	5/16	1/4	400
AMCB 0506	5/16	3/8	250
AMCB 0602	3/8	1/8	300
AMCB 0604	3/8	1/4	250
AMCB 0606	3/8	3/8	250
AMCB 0607	3/8	1/2	200
AMCB 0706	1/2	3/8	200
AMCB 0707	1/2	1/2	150

MCBB - Male Connector Big o-ring

BSP(P) Thread



PART NO.	Tube O.D.	BSP(P) Thread	Qty / Box
AMCBB 0602	3/8	1/8	300
AMCBB 0604	3/8	1/4	300

MCW - Male Connector

BSW Thread



PART NO.	Tube O.D.	BSW Thread	Qty / Box
AMCW 04 9/16	1/4	9/16	400
AMCW 0507	5/16	1/2	250
AMCW 05 9/16	5/16	9/16	250
AMCW 0607	3/8	1/2	200
AMCW 06 9/16	3/8	9/16	200

ME - Male Elbow

NPTF Thread



PART NO.	Tube O.D.	NPTF Thread	Qty / Box
AME 0302	3/16	1/8	500
AME 0402	1/4	1/8	500
AME 0404	1/4	1/4	350
AME 0406	1/4	3/8	300
AME 0504	5/16	1/4	300
AME 0506	5/16	3/8	250
AME 0604	3/8	1/4	250
AME 0606	3/8	3/8	250
AME 0706	1/2	3/8	200
AME 0707	1/2	1/2	150

MES - Male Elbow Swivel

NPTF Thread



PART NO.	Tube O.D.	NPTF Thread	Qty / Box
AMES 0102	5/32	1/8	500
AMES 0104	5/32	1/4	400
AMES 0302	3/16	1/8	500
AMES 0402	1/4	1/8	300
AMES 0404	1/4	1/4	250
AMES 0502	5/16	1/8	200
AMES 0504	5/16	1/4	200
AMES 0506	5/16	3/8	200
AMES 0604	3/8	1/4	150
AMES 0606	3/8	3/8	100
AMES 0706	1/2	3/8	100
AMES 0707	1/2	1/2	100

MCBT - Male Connector

BSPT(PT) Thread



PART NO.	Tube O.D.	BSPT(PT) Thread	Qty / Box
AMCBT 0102	5/32	1/8	500
AMCBT 0104	5/32	1/4	500
AMCBT 0302	3/16	1/8	500
AMCBT 0304	3/16	1/4	500
AMCBT 0402	1/4	1/8	500
AMCBT 0404	1/4	1/4	400
AMCBT 0406	1/4	3/8	300
AMCBT 0407	1/4	1/2	200
AMCBT 0502	5/16	1/8	400
AMCBT 0504	5/16	1/4	400
AMCBT 0506	5/16	3/8	350
AMCBT 0602	3/8	1/8	300
AMCBT 0604	3/8	1/4	300
AMCBT 0606	3/8	3/8	300
AMCBT 0607	3/8	1/2	200
AMCBT 0706	1/2	3/8	200
AMCBT 0707	1/2	1/2	150

SAB - Stem Adapter

BSP(P) Thread



PART NO.	Stem O.D.	BSP(P) Thread	Qty / Box
ASAB 0604	3/8	1/4	400
ASAB 0606	3/8	3/8	250
ASAB 0607	3/8	1/2	200
ASAB 0707	1/2	1/2	150

MCF - Male Connector

MFL Thread



PART NO.	Tube O.D.	MFL Thread	Qty / Box
AMCF 0505	5/16	5/16	300
AMCF 0604	3/8	1/4	300
AMCF 0507N	5/16	1/2	300
AMCF 0607N	3/8	1/2	300

- MFL Thread
MFL 1/4 Corresponds to a 7/16 - 20 UNF
MFL 5/16 Corresponds to a 1/2 - 20 UNF
MFL 3/8 Corresponds to a 5/8 - 18 UNF
MFL 1/2 Corresponds to a 3/4 - 16 UNF

EU - Elbow Union



PART NO.	Tube O.D.	Tube O.D.	Qty / Box
AEU 0101	5/32	5/32	700
AEU 0303	3/16	3/16	700
AEU 0404	1/4	1/4	350
AEU 0501	5/16	5/32	400
AEU 0503	5/16	3/16	400
AEU 0504	5/16	1/4	300
AEU 0505	5/16	5/16	300
AEU 0603	3/8	3/16	200
AEU 0604	3/8	1/4	200
AEU 0605	3/8	5/16	200
AEU 0606	3/8	3/8	200
AEU 0704	1/2	1/4	150
AEU 0705	1/2	5/16	150
AEU 0706	1/2	3/8	150
AEU 0707	1/2	1/2	150

ACETAL FITTINGS (GRAY / INCH)

TEU - Tube Elbow Union



PART NO.	Tube O.D.	Stem O.D.	Qty / Box
ATEU 0101	5/32	5/32	800
ATEU 0303	3/16	3/16	600
ATEU 0306	3/16	3/8	500
ATEU 0404	1/4	1/4	500
ATEU 0406	1/4	3/8	400
ATEU 0505	5/16	5/16	350
ATEU 0506	5/16	3/8	350
ATEU 0606	3/8	3/8	250
ATEU 0607	3/8	1/2	200
ATEU 0707	1/2	1/2	150

FAU - Female Adapter

UNS Thread (Cone Type)



PART NO.	Tube O.D.	UNS Thread	Qty / Box
AFAU 04 7/16C	1/4	7/16 - 24	400
AFAU 05 7/16C	5/16	7/16 - 24	350
AFAU 06 7/16C	3/8	7/16 - 24	300

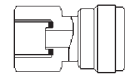

FA - Female Adapter

NPTF Thread



PART NO.	Tube O.D.	NPTF Thread	Qty / Box
AFA 0402	1/4	1/8	400
AFA 0404	1/4	1/4	400
AFA 0502	5/16	1/8	300
AFA 0504	5/16	1/4	300
AFA 0602	3/8	1/8	300
AFA 0604	3/8	1/4	300

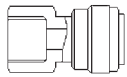

FAB - Female Adapter

BSP(P) Thread (Flat Type)



PART NO.	Tube O.D.	BSP(P) Thread	Qty / Box
AFAB 0508F	5/16	5/8	150
AFAB 0507F	5/16	1/2	250
AFAB 0607F	3/8	1/2	200
AFAB 0608F	3/8	5/8	150
AFAB 0706F	1/2	3/8	200
AFAB 0707F	1/2	1/2	150
AFAB 0708F	1/2	5/8	150



FAUN - Female Adapter

UN Thread (V - Type)



PART NO.	Tube O.D.	UN Thread	Qty / Box
AFAUN 05 1/2V	5/16	1/2 - 16	350
AFAUN 06 1/2V	3/8	1/2 - 16	200
AFAUN 07 1/2V	1/2	1/2 - 16	150



FAB - Female Adapter

BSP(P) Thread (Cone Type)



PART NO.	Tube O.D.	BSP(P) Thread	Qty / Box
AFAB 0406C	1/4	3/8	200
AFAB 0407C	1/4	1/2	200
AFAB 0506C	5/16	3/8	200
AFAB 0507C	5/16	1/2	200
AFAB 0606C	3/8	3/8	200
AFAB 0607C	3/8	1/2	200
AFAB 0608C	3/8	5/8	150
AFAB 0708C	1/2	5/8	150

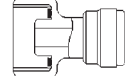

FAUF - Female Adapter

UNF Thread (Cone Type)



PART NO.	Tube O.D.	UNF Thread	Qty / Box
AFAUF 04 7/16C	1/4	7/16 - 20	400
AFAUF 05 7/16C	5/16	7/16 - 20	300
AFAUF 06 7/16C	3/8	7/16 - 20	300



FAUF - Female Adapter

UNF Thread (V - Type)



PART NO.	Tube O.D.	UNF Thread	Qty / Box
AFAUF 04 7/16V	1/4	7/16 - 20	400
AFAUF 05 7/16V	5/16	7/16 - 20	300
AFAUF 06 7/16V	3/8	7/16 - 20	300
AFAUF 06 5/8V	3/8	5/8 - 18	300

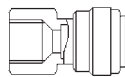

- 7/16 UNF Corresponds to a 1/4 MFL
- 5/8 UNF Corresponds to a 3/8 MFL

SA - Stem Adapter

NPTF Thread



PART NO.	Stem O.D.	NPTF Thread	Qty / Box
ASA 0102	5/32	1/8	800
ASA 0104	5/32	1/4	500
ASA 0302	3/16	1/8	800
ASA 0402	1/4	1/8	500
ASA 0404	1/4	1/4	500
ASA 0502	5/16	1/8	500
ASA 0504	5/16	1/4	400
ASA 0506	5/16	3/8	300
ASA 0604	3/8	1/4	300
ASA 0606	3/8	3/8	300
ASA 0706	1/2	3/8	250
ASA 0707	1/2	1/2	150

TBC - Tube Barb Connector



PART NO.	Stem O.D.	Tube I.D.	Qty / Box
ATBC 0403	1/4	3/16	1000
ATBC 0404	1/4	1/4	1000
ATBC 0405	1/4	5/16	800
ATBC 0503	5/16	3/16	800
ATBC 0504	5/16	1/4	800
ATBC 0505	5/16	5/16	700
ATBC 0506	5/16	3/8	700
ATBC 0604	3/8	1/4	500
ATBC 0605	3/8	5/16	500
ATBC 0606	3/8	3/8	400
ATBC 0607	3/8	1/2	300
ATBC 0706	1/2	3/8	300
ATBC 0707	1/2	1/2	300

SABT - Stem Adapter

BSPT(PT) Thread



PART NO.	Stem O.D.	BSPT(PT) Thread	Qty / Box
ASABT 0302	3/16	1/8	800
ASABT 0504	5/16	1/4	400
ASABT 0506	5/16	3/8	300
ASABT 0604	3/8	1/4	400
ASABT 0606	3/8	3/8	300
ASABT 0707	1/2	1/2	150

TEB - Tube Elbow Barb connector



PART NO.	Stem O.D.	Tube I.D.	Qty / Box
ATEB 0404	1/4	1/4	800
ATEB 0405	1/4	5/16	800
ATEB 0504	5/16	1/4	700
ATEB 0505	5/16	5/16	600
ATEB 0604	3/8	1/4	600
ATEB 0605	3/8	5/16	600
ATEB 0606	3/8	3/8	550

SAW - Stem Adapter

BSW Thread



PART NO.	Stem O.D.	BSW Thread	Qty / Box
ASAW 05 9/16	5/16	9/16	150
ASAW 0 6 0 7	3/8	1/2	150
ASAW 06 9/16	3/8	9/16	150

TU - Tee Union

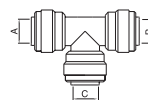

PART NO.	Tube O.D. (A)	Tube O.D. (B)	Tube O.D. (C)	Qty / Box
ATU 010101	5/32	5/32	5/32	350
ATU 030303	3/16	3/16	3/16	350
ATU 040404	1/4	1/4	1/4	300
ATU 040405	1/4	1/4	5/16	250
ATU 050505	5/16	5/16	5/16	200
ATU 060604	3/8	3/8	1/4	150
ATU 060606	3/8	3/8	3/8	150
ATU 070706	1/2	1/2	3/8	100
ATU 070707	1/2	1/2	1/2	100

RD - ReDucer



PART NO.	Tube O.D.	Stem O.D.	Qty / Box
ARD 0104	5/32	1/4	800
ARD 0305	3/16	5/16	700
ARD 0306	3/16	3/8	600
ARD 0405	1/4	5/16	700
ARD 0406	1/4	3/8	500
ARD 0506	5/16	3/8	400
ARD 0507	5/16	1/2	300
ARD 0607	3/8	1/2	300

MTS - Male Tee Swivel

NPTF Thread



PART NO.	Tube O.D.	NPTF Thread	Qty / Box
AMTS 0102	5/32	1/8	500
AMTS 0104	5/32	1/4	400
AMTS 0302	3/16	1/8	300
AMTS 0402	1/4	1/8	250
AMTS 0404	1/4	1/4	200
AMTS 0502	5/16	1/8	200
AMTS 0504	5/16	1/4	180
AMTS 0506	5/16	3/8	150
AMTS 0604	3/8	1/4	130
AMTS 0606	3/8	3/8	100
AMTS 0706	1/2	3/8	70
AMTS 0707	1/2	1/2	70

ACETAL FITTINGS (GRAY / INCH)

MRS - Male Run Swivel

NPTF Thread



PART NO.	Tube O.D.	NPTF Thread	Qty / Box
AMRS 0102	5/32	1/8	500
AMRS 0104	5/32	1/4	400
AMRS 0302	3/16	1/8	300
AMRS 0402	1/4	1/8	300
AMRS 0404	1/4	1/4	200
AMRS 0502	5/16	1/8	200
AMRS 0504	5/16	1/4	200
AMRS 0506	5/16	3/8	150
AMRS 0604	3/8	1/4	130
AMRS 0606	3/8	3/8	100
AMRS 0706	1/2	3/8	80
AMRS 0707	1/2	1/2	80

THWD - Three Way Divider



PART NO.	Tube O.D.	Tube O.D.	Qty / Box
ATHWD 0604	3/8	1/4	150
ATHWD 0606	3/8	3/8	50
ATHWD 0706	1/2	3/8	50

PL - PLug



PART NO.	Stem O.D.	Qty / Box
APL 01	5/32	1000
APL 03	3/16	1000
APL 04	1/4	1000
APL 05	5/16	700
APL 06	3/8	500
APL 07	1/2	400

OC - Offset Connector



PART NO.	Tube O.D.	Tube O.D.	Qty / Box
AOC 0604	3/8	1/4	300
AOC 0705	1/2	5/16	200

UB - U Bend



PART NO.	Tube O.D.	Tube O.D.	Qty / Box
AUB 0404	1/4	1/4	300
AUB 0505	5/16	5/16	250
AUB 0606	3/8	3/8	150
AUB 0707	1/2	1/2	100

UC - Union Connector



PART NO.	Tube O.D.	Tube O.D.	Qty / Box
AUC 0101	5/32	5/32	500
AUC 0303	3/16	3/16	500
AUC 0401	1/4	5/32	500
AUC 0403	1/4	3/16	400
AUC 0404	1/4	1/4	350
AUC 0501	5/16	5/32	400
AUC 0503	5/16	3/16	400
AUC 0504	5/16	1/4	300
AUC 0505	5/16	5/16	300
AUC 0601	3/8	5/32	300
AUC 0603	3/8	3/16	300
AUC 0604	3/8	1/4	250
AUC 0605	3/8	5/16	250
AUC 0606	3/8	3/8	250
AUC 0705	1/2	5/16	200
AUC 0706	1/2	3/8	200
AUC 0707	1/2	1/2	150
AUC 067.5	3/8	7.5 mm	250

DEU - Dispensing Elbow Union



PART NO.	Tube O.D.	Stem O.D.	Qty / Box
ADEU 0606	3/8	3/8	250

TES - Tube End Stop



PART NO.	Tube O.D.	Qty / Box
ATES 04	1/4	700
ATES 05	5/16	600
ATES 06	3/8	300
ATES 07	1/2	300

DST - Dispensing Stem



PART NO.	Stem O.D.	Stem O.D.	Qty / Box
ADST 0606	3/8	3/8	400

TWD - Two Way Divider



PART NO.	Tube in	Tube out	Qty / Box
ATWD 0101	5/32	5/32	400
ATWD 0404	1/4	1/4	300
ATWD 0505	5/16	5/16	200
ATWD 0605	3/8	5/16	150
ATWD 0606	3/8	3/8	150
ATWD 0607	3/8	1/2	100
ATWD 0707	1/2	1/2	100

BU - Bulkhead Union



PART NO.	Tube O.D.	Tube O.D.	Thread Size	Qty / Box
ABU 0101	5/32	5/32	M16XP1	300
ABU 0303	3/16	3/16	M16XP1	300
ABU 0404	1/4	1/4	M16XP1	250
ABU 0406	1/4	3/8	M20XP1.5	200
ABU 0505	5/16	5/16	M20XP1.5	150
ABU 0604	3/8	1/4	M20XP1.5	150
ABU 0606	3/8	3/8	M20XP1.5	150
ABU 0707	1/2	1/2	M27XP1.5	70

CR - Cross



PART NO.	Tube O.D.	Qty / Box
ACR 0101	5/32	300
ACR 0404	1/4	250
ACR 0505	5/16	200
ACR 0606	3/8	100
ACR 0707	1/2	80

FAB - Female Adapter

BSP(P) Thread



PART NO.	Tube O.D.	BSP(P) Thread	Qty / Box
AFAB 0407F	1/4	1/2	100
AFAB 0409F	1/4	3/4	100
AFAB 0509F	5/16	3/4	100
AFAB 0609F	3/8	3/4	100
AFAB 0809F	5/8	3/4	50

MESBT - Male Elbow Swivel

BSPT(PT) Thread



PART NO.	Tube O.D.	BSPT(PT) Thread	Qty / Box
AMESBT 0104	5/32	1/4	400
AMESBT 0302	3/16	1/8	400
AMESBT 0306	3/16	3/8	300
AMESBT 0406	1/4	3/8	200
AMESBT 0407	1/4	1/2	200
AMESBT 0504	5/16	1/4	200
AMESBT 0506	5/16	3/8	200
AMESBT 0507	5/16	1/2	150
AMESBT 0604	3/8	1/4	150
AMESBT 0606	3/8	3/8	150
AMESBT 0707	1/2	1/2	100

BFU - Both Female Union

BSP(P) Thread



PART NO.	BSP(P) Thread	BSP(P) Thread	Qty / Box
ABFU 0409	1/4	3/4	150

STU - Stackable Tee Union

New



PART NO.	Tube O.D.	Tube O.D.	Stem O.D.	Qty / Box
ASTU 040404	1/4	1/4	1/4	300
ASTU 060606	3/8	3/8	3/8	150
ASTU 070707	1/2	1/2	1/2	100

FAB - Female Adapter

BSP(P) Thread

New



PART NO.	Tube O.D.	BSP(P) Thread	Qty / Box
AFAB 0409F-1	1/4	3/4	200
AFAB 0609F-1	3/8	3/4	200
AFAB 0709F-1	1/2	3/4	150

MTUR - Male Tee Union

NPTF Thread

New



PART NO.	Tube O.D.	Tube O.D.	NPTF Thread	Qty / Box
AMTUR 040404	1/4	1/4	1/4	300
AMTUR 060606	3/8	3/8	3/8	150

FAN - Female Adapter

NH Thread



PART NO.	Tube O.D.	NH Thread	Qty / Box
AFAN 0409F	1/4	3/4	100
AFAN 0509F	5/16	3/4	100
AFAN 0609F	3/8	3/4	100
AFAN 0809F	5/8	3/4	50

BTU - Branch Tee Union

New



PART NO.	Tube O.D.	Tube O.D.	Stem O.D.	Qty / Box
ABTU 040404	1/4	1/4	1/4	300
ABTU 060606	3/8	3/8	3/8	150
ABTU 070707	1/2	1/2	1/2	100

Adaptability

- For maximum flexibility, fittings may be combined to provide wider functions.
- Unlike some competitors' products, separation and reuse is easy.

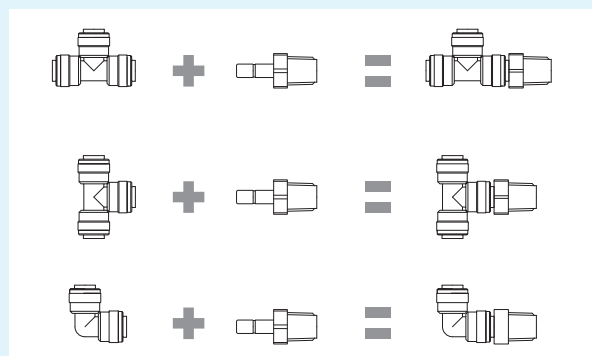

ACETAL FITTINGS (WHITE / INCH)



■ Suitable for

- **Water & foods use :** *DMfit*[®] products are manufactured from safe, non-toxic materials meeting the requirements of the US FDA, WRAS, ANSI/NSF-51, 61, and SK Zert. Our products are widely used in water purification, food/beverage and pneumatic systems.
- **Function & Quality :** *DMfit*[®] provides quick and convenient assembly - saving time & expense. Our ISO9001, 14001 registered quality system ensures our customers a superior level of product quality. Defects are easily detectable and maintenance is easy with its easy dismantling for access.
- **Collet Design :** Our unique oval collet design is superior and more practical, and is an improvement welcomed by our world-wide customers in all industries.
- **Applications :** Beyond water and food use, fittings can be used with air, gases, vacuum, & liquids. And all connections can be assembled & disassembled repeatedly. A broad of sizes covers a broad scope of applications.
- **Color :** White Acetal Copolymer

MC - Male Connector



PART NO.	Tube O.D.	NPTF Thread	
		NPTF Thread	Qty / Box
AMC 0102W	5/32	1/8	500
AMC 0104W	5/32	1/4	500
AMC 0302W	3/16	1/8	500
AMC 0402W	1/4	1/8	400
AMC 0404W	1/4	1/4	350
AMC 0406W	1/4	3/8	300
AMC 0407W	1/4	1/2	150
AMC 0502W	5/16	1/8	400
AMC 0504W	5/16	1/4	400
AMC 0506W	5/16	3/8	350
AMC 0602W	3/8	1/8	300
AMC 0604W	3/8	1/4	300
AMC 0606W	3/8	3/8	250
AMC 0607W	3/8	1/2	200
AMC 0706W	1/2	3/8	200
AMC 0707W	1/2	1/2	150
AMC 0806W	5/8	3/8	80
AMC 0807W	5/8	1/2	80
AMC 1009W	7/8	3/4	40
AMC 1011W	7/8	1	40

MCB - Male Connector



PART NO.	Tube O.D.	BSP(P) Thread	
		BSP(P) Thread	Qty / Box
AMCB 0807W	5/8	1/2	100
AMCB 0809W	5/8	3/4	100
AMCB 1009W	7/8	3/4	50

ME - Male Elbow



PART NO.	Tube O.D.	NPTF Thread	
		NPTF Thread	Qty / Box
AME 0302W	3/16	1/8	500
AME 0402W	1/4	1/8	500
AME 0404W	1/4	1/4	350
AME 0406W	1/4	3/8	300
AME 0504W	5/16	1/4	300
AME 0506W	5/16	3/8	300
AME 0604W	3/8	1/4	250
AME 0606W	3/8	3/8	250
AME 0706W	1/2	3/8	200
AME 0707W	1/2	1/2	150
AME 0806W	5/8	3/8	80
AME 0807W	5/8	1/2	40

EU - Elbow Union



PART NO.	Tube O.D.	Tube O.D.	Qty / Box
AEU 0303W	3/16	3/16	700
AEU 0404W	1/4	1/4	350
AEU 0501W	5/16	5/32	500
AEU 0503W	5/16	3/16	400
AEU 0504W	5/16	1/4	300
AEU 0505W	5/16	5/16	300
AEU 0603W	3/8	3/16	200
AEU 0604W	3/8	1/4	200
AEU 0605W	3/8	5/16	200
AEU 0606W	3/8	3/8	200
AEU 0704W	1/2	1/4	150
AEU 0705W	1/2	5/16	150
AEU 0706W	1/2	3/8	150
AEU 0707W	1/2	1/2	150
AEU 0808W	5/8	5/8	100
AEU 1008W	7/8	5/8	50
AEU 1010W	7/8	7/8	50

TU - Tee Union



PART NO.	Tube O.D. (A)	Tube O.D. (B)	Tube O.D. (C)	Qty / Box
ATU 010101W	5/32	5/32	5/32	350
ATU 030303W	3/16	3/16	3/16	350
ATU 040404W	1/4	1/4	1/4	300
ATU 050505W	5/16	5/16	5/16	200
ATU 060604W	3/8	3/8	1/4	150
ATU 060606W	3/8	3/8	3/8	150
ATU 070706W	1/2	1/2	3/8	100
ATU 070707W	1/2	1/2	1/2	100
ATU 080804W	5/8	5/8	1/4	50
ATU 080807W	5/8	5/8	1/2	50
ATU 080808W	5/8	5/8	5/8	40
ATU 080810W	5/8	5/8	7/8	40
ATU 100810W	7/8	5/8	7/8	30
ATU 101008W	7/8	7/8	5/8	30
ATU 100808W	7/8	5/8	5/8	40
ATU 101010W	7/8	7/8	7/8	30

TTU - Tube Tee Union connector



PART NO.	Tube O.D.	Tube O.D.	Stem O.D.	Qty / Box
ATTU 080808W	5/8	5/8	5/8	50

FAB - Female Adapter

BSP(P) Thread (Cone Type)



PART NO.	Tube O.D.	BSP(P) Thread	Qty / Box
AFAB 0406CW	1/4	3/8	250
AFAB 0407CW	1/4	1/2	200
AFAB 0506CW	5/16	3/8	200
AFAB 0507CW	5/16	1/2	200
AFAB 0606CW	3/8	3/8	200
AFAB 0607CW	3/8	1/2	200
AFAB 0608CW	3/8	5/8	150
AFAB 0708CW	1/2	5/8	150

FA - Female Adapter

NPTF Thread



PART NO.	Tube O.D.	NPTF Thread	Qty / Box
AFA 0402W	1/4	1/8	400
AFA 0404W	1/4	1/4	400
AFA 0502W	5/16	1/8	300
AFA 0504W	5/16	1/4	300
AFA 0602W	3/8	1/8	300
AFA 0604W	3/8	1/4	300
AFA 0807W	5/8	1/2	100
AFA 0809W	5/8	3/4	100
AFA 1009W	7/8	3/4	50
AFA 1011W	7/8	1	40

FAB - Female Adapter

BSP(P) Thread (Flat Type)



PART NO.	Tube O.D.	BSP(P) Thread	Qty / Box
AFAB 0508FW	5/16	5/8	250
AFAB 0607FW	3/8	1/2	200
AFAB 0608FW	3/8	5/8	150
AFAB 0706FW	1/2	3/8	200
AFAB 0707FW	1/2	1/2	150
AFAB 0708FW	1/2	5/8	150

FAUF - Female Adapter

UNF Thread (Cone Type)



PART NO.	Tube O.D.	UNF Thread	Qty / Box
AFAUF 04 7/16CW	1/4	7/16 - 20	400
AFAUF 05 7/16CW	5/16	7/16 - 20	350
AFAUF 06 7/16CW	3/8	7/16 - 20	300

FAU - Female Adapter

UNS Thread (Cone Type)



PART NO.	Tube O.D.	UNS Thread	Qty / Box
AFAU 04 7/16CW	1/4	7/16 - 24	400
AFAU 05 7/16CW	5/16	7/16 - 24	350
AFAU 06 7/16CW	3/8	7/16 - 24	300

FAUF - Female Adapter

UNF Thread (V - Type)



PART NO.	Tube O.D.	UNF Thread	Qty / Box
AFAUF 04 7/16VW	1/4	7/16 - 20	400
AFAUF 05 7/16VW	5/16	7/16 - 20	300
AFAUF 06 7/16VW	3/8	7/16 - 20	300
AFAUF 06 5/8VW	3/8	5/8 - 18	350

- 7/16 UNF Corresponds to a 1/4 MFL
- 5/8 UNF Corresponds to a 3/8 MFL

FAUN - Female Adapter

UN Thread (V - Type)



PART NO.	Tube O.D.	UN Thread	Qty / Box
AFAUN 05 1/2VW	5/16	1/2 - 16	350
AFAUN 06 1/2VW	3/8	1/2 - 16	200
AFAUN 07 1/2VW	1/2	1/2 - 16	150

ACETAL FITTINGS (WHITE / INCH)

HA - Hub Adapter

NPSH Thread



PART NO.	Tube O.D.	NPSH Thread	Qty / Box
AHA 1011W	7/8	1	400

DA - Drain Adapter

NPSH Thread



PART NO.	Tube O.D.	NPSH Thread	Qty / Box
ADA 0809W	5/8	3/4	50

SA - Stem Adapter

NPTF Thread



PART NO.	Stem O.D.	NPTF Thread	Qty / Box
ASA 0102W	5/32	1/8	800
ASA 0104W	5/32	1/4	500
ASA 0302W	3/16	1/8	800
ASA 0402W	1/4	1/8	500
ASA 0404W	1/4	1/4	500
ASA 0502W	5/16	1/8	500
ASA 0504W	5/16	1/4	400
ASA 0506W	5/16	3/8	300
ASA 0604W	3/8	1/4	300
ASA 0606W	3/8	3/8	300
ASA 0706W	1/2	3/8	250
ASA 0707W	1/2	1/2	150

BU - Bulkhead Union



PART NO.	Tube O.D.	Tube O.D.	Thread Size	Qty / Box
ABU 0101W	5/32	5/32	M16XP1	300
ABU 0303W	3/16	3/16	M16XP1	300
ABU 0404W	1/4	1/4	M16XP1	250
ABU 0406W	1/4	3/8	M20XP1.5	200
ABU 0505W	5/16	5/16	M20XP1.5	150
ABU 0604W	3/8	1/4	M20XP1.5	150
ABU 0606W	3/8	3/8	M20XP1.5	150
ABU 0707W	1/2	1/2	M27XP1.5	70

SABT - Stem Adapter

BSPT(PT) Thread



PART NO.	Stem O.D.	BSPT(PT) Thread	Qty / Box
ASABT 0302W	3/16	1/8	800
ASABT 0504W	5/16	1/4	400
ASABT 0506W	5/16	3/8	300
ASABT 0604W	3/8	1/4	400
ASABT 0606W	3/8	3/8	300
ASABT 0707W	1/2	1/2	150

CR - CRoss



PART NO.	Tube O.D.	Qty / Box
ACR 0101W	5/32	300
ACR 0404W	1/4	250
ACR 0505W	5/16	200
ACR 0606W	3/8	100
ACR 0707W	1/2	80

THWD - Three Way Divider



PART NO.	Tube O.D.	Tube O.D.	Qty / Box
ATHWD 0604W	3/8	1/4	150
ATHWD 0706W	1/2	3/8	50

UC - Union Connector



PART NO.	Tube O.D.	Tube O.D.	Qty / Box
AUC 0101W	5/32	5/32	500
AUC 0303W	3/16	3/16	500
AUC 0404W	1/4	1/4	350
AUC 0501W	5/16	5/32	400
AUC 0503W	5/16	3/16	400
AUC 0504W	5/16	1/4	300
AUC 0505W	5/16	5/16	300
AUC 0603W	3/8	3/16	300
AUC 0604W	3/8	1/4	250
AUC 0605W	3/8	5/16	250
AUC 0606W	3/8	3/8	250
AUC 0705W	1/2	5/16	200
AUC 0706W	1/2	3/8	200
AUC 0707W	1/2	1/2	150
AUC 067.5W	3/8	7.5 (mm)	250
AUC 0807W	5/8	1/2	100
AUC 0808W	5/8	5/8	100
AUC 1008W	7/8	5/8	50
AUC 1010W	7/8	7/8	50

TEU - Tube Elbow Union



PART NO.	Tube O.D.	Stem O.D.	Qty / Box
ATEU 0101W	5/32	5/32	800
ATEU 0303W	3/16	3/16	600
ATEU 0306W	3/16	3/8	500
ATEU 0404W	1/4	1/4	500
ATEU 0406W	1/4	3/8	400
ATEU 0505W	5/16	5/16	350
ATEU 0506W	5/16	3/8	350
ATEU 0606W	3/8	3/8	250
ATEU 0607W	3/8	1/2	200
ATEU 0707W	1/2	1/2	150
ATEU 0808W	5/8	5/8	50
ATEU 1010W	7/8	7/8	50

TES - Tube End Stop



PART NO.	Tube O.D.	Qty / Box
ATES 04W	1/4	800
ATES 05W	5/16	600
ATES 06W	3/8	300
ATES 07W	1/2	300
ATES 08W	5/8	100
ATES 10W	7/8	50

SUC - Swivel Union Connector

BSP(P) Thread



PART NO.	Tube O.D.	BSP(P) Thread	Qty / Box
ASUC 0807W	5/8	1/2	50
ASUC 0809W	5/8	3/4	50
ASUC 1009W	7/8	3/4	40

SEU - Swivel Elbow Union

BSP(P) Thread



PART NO.	Tube O.D.	BSP(P) Thread	Qty / Box
ASEU 0807W	5/8	1/2	50
ASEU 0809W	5/8	3/4	50

TWD - Two Way Divider



PART NO.	Tube in	Tube out	Qty / Box
ATWD 0101W	5/32	5/32	400
ATWD 0404W	1/4	1/4	300
ATWD 0505W	5/16	5/16	200
ATWD 0605W	3/8	5/16	150
ATWD 0606W	3/8	3/8	150
ATWD 0607W	3/8	1/2	100
ATWD 0707W	1/2	1/2	100

KFA - Kitchen Faucet Adapter

NPSM Thread



PART NO.	Tube O.D.	NPSM Thread	Qty / Box
AKFA 0407W	1/4	1/2-14	100
AKFA 0607W	3/8	1/2-14	100

- For installing undercounter filters & RO systems



UB - U Bend



PART NO.	Tube O.D.	Tube O.D.	Qty / Box
AUB 0404W	1/4	1/4	350
AUB 0505W	5/16	5/16	250
AUB 0606W	3/8	3/8	150
AUB 0707W	1/2	1/2	100
AUB 0808W	5/8	5/8	60
AUB 1010W	7/8	7/8	40

MTU - Male Tee Union

NPTF Thread



PART NO.	Tube O.D.	NPTF Thread	Qty / Box
AMTU 0404W	1/4	1/4	300

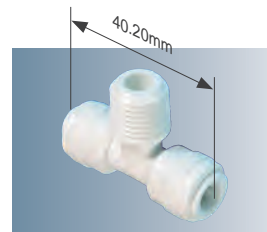

SVA - Stop Valve Adapter

UNEF Thread



PART NO.	Tube O.D.	UNEF Thread	Qty / Box
ASVA 04 9/16W	1/4	9/16-24	200
ASVA 06 9/16W	3/8	9/16-24	150

- For an undercounter filter systems



BBC - BarB Connector



PART NO.	Tube O.D.	Tube I.D.	Qty / Box
ABBC 0807W	5/8	1/2	100
ABBC 1007W	7/8	1/2	50
ABBC 1009W	7/8	3/4	40

PL - PLug



PART NO.	Stem O.D.	Qty / Box
APL 01W	5/32	1000
APL 03W	3/16	1000
APL 04W	1/4	1000
APL 05W	5/16	700
APL 06W	3/8	500
APL 07W	1/2	400
APL 08W	5/8	200
APL 10W	7/8	100

RD - ReDucer



PART NO.	Tube O.D.	Stem O.D.	Qty / Box
ARD 0104W	5/32	1/4	800
ARD 0305W	3/16	5/16	700
ARD 0306W	3/16	3/8	600
ARD 0405W	1/4	5/16	700
ARD 0406W	1/4	3/8	500
ARD 0408W	1/4	5/8	300
ARD 0506W	5/16	3/8	400
ARD 0507W	5/16	1/2	300
ARD 0607W	3/8	1/2	300

ACETAL FITTINGS (WHITE / INCH)

FC - Filter Connector



PART NO.	Tube O.D.	Tube O.D.	Qty / Box
AFC 0404W	1/4	1/4	300

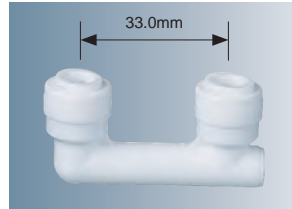

EL - EnLarger



PART NO.	Tube O.D.	Stem O.D.	Qty / Box
AEL 0605W	3/8	5/16	400
AEL 0706W	1/2	3/8	300

BFU - Both Female Union

BSP(P) Thread



PART NO.	BSP(P) Thread	BSP(P) Thread	Qty / Box
ABFU 0409W	1/4	3/4	150

FAN - Female Adapter

NH Thread



PART NO.	Tube O.D.	NH Thread	Qty / Box
AFAN 0409FW	1/4	3/4	100
AFAN 0509FW	5/16	3/4	100
AFAN 0609FW	3/8	3/4	100
AFAN 0809FW	5/8	3/4	50

PART NO.	Tube O.D. (mm)	NH Thread	Qty / Box
AFAN 0609FM	6	3/4	100
AFAN 0809FM	8	3/4	100
AFAN 1009FM	10	3/4	100

FAB - Female Adapter

BSP(P) Thread



PART NO.	Tube O.D.	BSP(P) Thread	Qty / Box
AFAB 0407FW	1/4	1/2	100
AFAB 0409FW	1/4	3/4	100
AFAB 0509FW	5/16	3/4	100
AFAB 0609FW	3/8	3/4	100
AFAB 0809FW	5/8	3/4	50

PART NO.	Tube O.D. (mm)	BSP(P) Thread	Qty / Box
AFAB 0609FM	6	3/4	100
AFAB 0809FM	8	3/4	100
AFAB 1009FM	10	3/4	100

FAB - Female Adapter

BSP(P) Thread

New



PART NO.	Tube O.D.	BSP(P) Thread	Qty / Box
AFAB 0409FW-1	1/4	3/4	200
AFAB 0609FW-1	3/8	3/4	200
AFAB 0709FW-1	1/2	3/4	150

STU - Stackable Tee Union

New



PART NO.	Tube O.D.	Tube O.D.	Stem O.D.	Qty / Box
ASTU 040404W	1/4	1/4	1/4	300
ASTU 060606W	3/8	3/8	3/8	150
ASTU 070707W	1/2	1/2	1/2	100

MTUR - Male Tee Union

NPTF Thread

New



PART NO.	Tube O.D.	Tube O.D.	NPTF Thread	Qty / Box
AMTUR 040404W	1/4	1/4	1/4	300
AMTUR 060606W	3/8	3/8	3/8	150

BTU - Branch Tee Union

New



PART NO.	Tube O.D.	Tube O.D.	Stem O.D.	Qty / Box
ABTU 040404W	1/4	1/4	1/4	300
ABTU 060606W	3/8	3/8	3/8	150
ABTU 070707W	1/2	1/2	1/2	100

BMC - Brass Male Connector

BSP(P) Thread



PART NO.	Tube O.D.	Metric Thread	Qty / Box
BMC 04M10	1/4	M10	500
BMC 06M10	3/8	M10	500

PART NO.	Tube O.D. (mm)	BSP(P) Thread	Qty / Box
BMCB 1004M	10	1/4	500

1. Chrome plating is by special request.
2. Manufactured after receipt of order.

BFAUF - Brass Female Adapter

UNF Thread



PART NO.	Tube O.D.	UNF Thread	Qty / Box
BFAUF 04 7/16V	1/4	7/16-20	400
BFAUF 06 7/16V	3/8	7/16-20	300
BFAUF 06 5/8V	3/8	5/8-18	250

- 7/16 UNF corresponds to a 1/4 MFL
 - 5/8 UNF corresponds to a 3/8 MFL
1. Chrome plating is by special request.
 2. Manufactured after receipt of order.

ACETAL FITTINGS (BLACK / METRIC)



■ Suitable for

- **Water & foods use :** *DMfit*[®] products are manufactured from safe, non-toxic materials meeting the requirements of the US FDA, WRAS, ANSI/NSF-51, 61, and SK Zert. Our products are widely used in water purification, food/beverage and pneumatic systems.
- **Function & Quality :** *DMfit*[®] provides quick and convenient assembly - saving time & expense. Our ISO9001, 14001 registered quality system ensures our customers a superior level of product quality. Defects are easily detectable and maintenance is easy with its easy dismantling for access.
- **Collet Design :** Our unique oval collet design is superior and more practical, and is an improvement welcomed by our world-wide customers in all industries.
- **Applications :** Beyond water and food use, fittings can be used with air, gases, vacuum, & liquids. And all connections can be assembled & disassembled repeatedly. A broad of sizes covers a broad scope of applications.
- **Color :** Black Acetal Copolymer

Part Numbering System

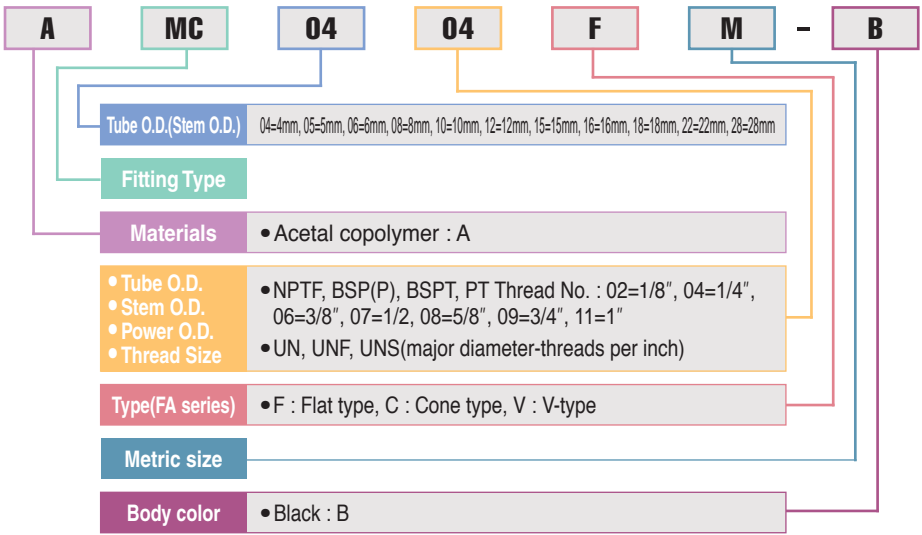

ME - Male Elbow



PART NO.	Tube O.D. (mm)	BSPT(PT) Thread	Qty / Box
AME 0602M	6	1/8	500
AME 0604M	6	1/4	400
AME 0606M	6	3/8	400
AME 0804M	8	1/4	300
AME 0806M	8	3/8	300
AME 1004M	10	1/4	250
AME 1006M	10	3/8	250
AME 1206M	12	3/8	200
AME 1207M	12	1/2	150
AME 1506M	15	3/8	100
AME 1507M	15	1/2	100
AME 1606M	16	3/8	100
AME 1607M	16	1/2	100

MES - Male Elbow Swivel



PART NO.	Tube O.D. (mm)	BSPT(PT) Thread	Qty / Box
AMES 0402M	4	1/8	500
AMES 0404M	4	1/4	400
AMES 0502M	5	1/8	500
AMES 0602M	6	1/8	300
AMES0604M	6	1/4	300
AMES 0802M	8	1/8	200
AMES 0804M	8	1/4	200
AMES 0806M	8	3/8	200
AMES 1004M	10	1/4	150
AMES 1006M	10	3/8	150
AMES 1206M	12	3/8	100
AMES 1207M	12	1/2	100

ACETAL FITTINGS (BLACK / METRIC)

MC - Male Connector



BSPT(PT) Thread

PART NO.	Tube O.D. (mm)	BSPT(PT) Thread	Qty / Box
AMC 0402M	4	1/8	500
AMC 0404M	4	1/4	500
AMC 0502M	5	1/8	500
AMC 0504M	5	1/4	500
AMC 0602M	6	1/8	400
AMC 0604M	6	1/4	500
AMC 0606M	6	3/8	300
AMC 0607M	6	1/2	250
AMC 0802M	8	1/8	400
AMC 0804M	8	1/4	400
AMC 0806M	8	3/8	350
AMC 1002M	10	1/8	300
AMC 1004M	10	1/4	300
AMC 1006M	10	3/8	300
AMC 1007M	10	1/2	200
AMC 1206M	12	3/8	200
AMC 1207M	12	1/2	200
AMC 1506M	15	3/8	100
AMC 1507M	15	1/2	100
AMC 1606M	16	3/8	100
AMC 1607M	16	1/2	100
AMC 1807M	18	1/2	80
AMC 2209M	22	3/4	80
AMC 2211M	22	1	40

MCB - Male Connector



BSP(P) Thread

PART NO.	Tube O.D. (mm)	BSP(P) Thread	Qty / Box
AMCB 0402M	4	1/8	500
AMCB 0404M	4	1/4	400
AMCB 0502M	5	1/8	400
AMCB 0504M	5	1/4	400
AMCB 0602M	6	1/8	400
AMCB 0604M	6	1/4	400
AMCB 0802M	8	1/8	400
AMCB 0804M	8	1/4	400
AMCB 0806M	8	3/8	250
AMCB 0807M	8	1/2	200
AMCB 1004M	10	1/4	300
AMCB 1006M	10	3/8	250
AMCB 1007M	10	1/2	200
AMCB 1206M	12	3/8	200
AMCB 1207M	12	1/2	150
AMCB 1507M	15	1/2	150
AMCB 1509M	15	3/4	100
AMCB 1607M	16	1/2	150
AMCB 1609M	16	3/4	100
AMCB 2209M	22	3/4	80

TEU - Tube Elbow Union



PART NO.	Tube O.D. (mm)	Stem O.D. (mm)	Qty / Box
ATEU 0404M	4	4	500
ATEU 0505M	5	5	500
ATEU 0606M	6	6	500
ATEU 0610M	6	10	400
ATEU 0806M	8	6	400
ATEU 0808M	8	8	350
ATEU 0810M	8	10	350
ATEU 1010M	10	10	250
ATEU 1212M	12	12	150
ATEU 1515M	15	15	100
ATEU 2222M	22	22	40

PART NO.	Tube O.D. (mm)	Stem O.D.	Qty / Box
ATEU 16M08	16	5/8	100

EU - Elbow Union



PART NO.	Tube O.D. (mm)	Tube O.D. (mm)	Qty / Box
AEU 0404M	4	4	700
AEU 0505M	5	5	700
AEU 0606M	6	6	400
AEU 0804M	8	4	500
AEU 0805M	8	5	400
AEU 0806M	8	6	300
AEU 0808M	8	8	300
AEU 1005M	10	5	300
AEU 1006M	10	6	300
AEU 1008M	10	8	200
AEU 1010M	10	10	200
AEU 1206M	12	6	200
AEU 1208M	12	8	200
AEU 1210M	12	10	150
AEU 1212M	12	12	150
AEU 1515M	15	15	80
AEU 1616M	16	16	80
AEU 1818M	18	18	60
AEU 2215M	22	15	50
AEU 2216M	22	16	50
AEU 2222M	22	22	40
AEU 2828M	28	28	20

MESB - Male Elbow Swivel



BSP(P) Thread

PART NO.	Tube O.D. (mm)	BSP(P) Thread	Qty / Box
AMESB 0402M	4	1/8	350
AMESB 0404M	4	1/4	350
AMESB 0502M	5	1/8	300
AMESB 0504M	5	1/4	300
AMESB 0602M	6	1/8	250
AMESB 0604M	6	1/4	250
AMESB 0802M	8	1/8	200
AMESB 0804M	8	1/4	200
AMESB 0806M	8	3/8	150
AMESB 1004M	10	1/4	140
AMESB 1006M	10	3/8	140
AMESB 1007M	10	1/2	100
AMESB 1206M	12	3/8	90
AMESB 1207M	12	1/2	80

RD - ReDucer



PART NO.	Tube O.D. (mm)	Stem O.D. (mm)	Qty / Box
ARD 0405M	4	5	800
ARD 0406M	4	6	700
ARD 0408M	4	8	700
ARD 0506M	5	6	700
ARD 0508M	5	8	700
ARD 0608M	6	8	600
ARD 0610M	6	10	500
ARD 0810M	8	10	400
ARD 0812M	8	12	300
ARD 1012M	10	12	300
ARD 1015M	10	15	250
ARD 1215M	12	15	200
ARD 1518M	15	18	150
ARD 1522M	15	22	100
ARD 1618M	16	18	100
ARD 1622M	16	22	100
ARD 1822M	18	22	80
ARD 2228M	22	28	50

PART NO.	Tube O.D.	Stem O.D.	Qty / Box
ARD 0615M	3/8	15mm	250
ARD 1512M	15	12mm	150

FA - Female Adapter

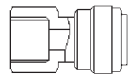

BSPT(PT) Thread

PART NO.	Tube O.D. (mm)	BSPT(PT) Thread	Qty / Box
AFA 0602M	6	1/8	500
AFA 0604M	6	1/4	400
AFA 0802M	8	1/8	300
AFA 0804M	8	1/4	300
AFA 1002M	10	1/8	300
AFA 1004M	10	1/4	300
AFA 1507M	15	1/2	100
AFA 1509M	15	3/4	100
AFA 1607M	16	1/2	100
AFA 1609M	16	3/4	100
AFA 2209M	22	3/4	50
AFA 2211M	22	1	40

FAB - Female Adapter



BSP(P) Thread

PART NO.	Tube O.D. (mm)	BSP(P) Thread	Qty / Box
AFAB 1507M	15	1/2	100
AFAB 1509M	15	3/4	100
AFAB 1607M	16	1/2	100
AFAB 1609M	16	3/4	100
AFAB 2209M	22	3/4	40

FAUN - Female Adapter



UN Thread (V - Type)

PART NO.	Tube O.D. (mm)	UN Thread	Qty / Box
AFAUN 08 1/2VM	8	1/2 - 16	350
AFAUN 10 1/2VM	10	1/2 - 16	200
AFAUN 12 1/2VM	12	1/2 - 16	200

EL - EnLarger



PART NO.	Tube O.D. (mm)	Stem O.D. (mm)	Qty / Box
AEL1510M	15	10	150
AEL 1512M	15	12	150
AEL1610M	16	10	150
AEL 1612M	16	12	150
AEL 2215M	22	15	60
AEL 2822M	28	22	50

PART NO.	Tube O.D. (mm)	Stem O.D.	Qty / Box
AEL 15M07	15	1/2	150
AEL 16M07	16	1/2	150
AEL 18M07	18	1/2	150

FAU - Female Adapter



UNS Thread (Cone Type)

PART NO.	Tube O.D. (mm)	UNS Thread	Qty / Box
AFAU 06 7/16CM	6	7/16 - 24	400
AFAU 08 7/16CM	8	7/16 - 24	350
AFAU 10 7/16CM	10	7/16 - 24	300

FAB - Female Adapter

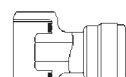

BSP(P) Thread (Cone Type)

PART NO.	Tube O.D. (mm)	BSP(P) Thread	Qty / Box
AFAB 0606CM	6	3/8	200
AFAB 0607CM	6	1/2	200
AFAB 0806CM	8	3/8	150
AFAB 0807CM	8	1/2	200
AFAB 1006CM	10	3/8	200
AFAB 1007CM	10	1/2	200
AFAB 1008CM	10	5/8	150
AFAB1206CM	12	3/8	150
AFAB 1208CM	12	5/8	150

FAUF - Female Adapter



UNF Thread (Cone Type)

PART NO.	Tube O.D. (mm)	UNF Thread	Qty / Box
AFAUF 06 7/16CM	6	7/16 - 20	400
AFAUF 08 7/16CM	8	7/16 - 20	300
AFAUF 10 7/16CM	10	7/16 - 20	300

ACETAL FITTINGS (BLACK / METRIC)

FAB - Female Adapter

BSP(P) Thread (Flat Type)

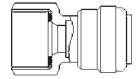

PART NO.	Tube O.D. (mm)	BSP(P) Thread	Qty / Box
AFAB 0804FM	8	1/4	200
AFAB 0808FM	8	5/8	200
AFAB 1004FM	10	1/4	200
AFAB 1007FM	10	1/2	150
AFAB 1008FM	10	5/8	150
AFAB 1206FM	12	3/8	150
AFAB 1207FM	12	1/2	150
AFAB 1208FM	12	5/8	150

FAB - Female Adapter

BSP(P) Thread

New



PART NO.	Tube O.D. (mm)	BSP(P) Thread	Qty / Box
AFAB 0609FM-1	6	3/4	200
AFAB 1009FM-1	10	3/4	200
AFAB 1209FM-1	12	3/4	150

FAUF - Female Adapter

UNF Thread (V - Type)

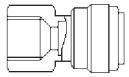

PART NO.	Tube O.D. (mm)	UNF Thread	Qty / Box
AFAUF 06 7/16VM	6	7/16 - 20	400
AFAUF 08 7/16VM	8	7/16 - 20	300
AFAUF 10 7/16VM	10	7/16 - 20	300
AFAUF 10 5/8VM	10	5/8 - 18	350

HA - Hub Adapter

NPSH Thread



PART NO.	Tube O.D. (mm)	NPSH Thread	Qty / Box
AHA 2211M	22	1	40

MRSB - Male Run Swivel

BSP(P) Thread



PART NO.	Tube O.D. (mm)	BSP(P) Thread	Qty / Box
AMRSB 0402M	4	1/8	300
AMRSB 0404M	4	1/4	300
AMRSB 0502M	5	1/8	250
AMRSB 0504M	5	1/4	250
AMRSB 0602M	6	1/8	200
AMRSB 0604M	6	1/4	200
AMRSB 0802M	8	1/8	150
AMRSB 0804M	8	1/4	150
AMRSB 0806M	8	3/8	150
AMRSB 1004M	10	1/4	130
AMRSB 1006M	10	3/8	100
AMRSB 1007M	10	1/2	100
AMRSB 1206M	12	3/8	80
AMRSB 1207M	12	1/2	80

MRS - Male Run Swivel

BSPT(PT) Thread



PART NO.	Tube O.D. (mm)	BSPT(PT) Thread	Qty / Box
AMRS 0402M	4	1/8	500
AMRS 0404M	4	1/4	400
AMRS 0502M	5	1/8	300
AMRS 0504M	5	1/4	300
AMRS 0602M	6	1/8	250
AMRS 0802M	8	1/8	200
AMRS 0804M	8	1/4	200
AMRS 0806M	8	3/8	150
AMRS 1004M	10	1/4	130
AMRS 1006M	10	3/8	100
AMRS 1007M	10	1/2	100
AMRS 1206M	12	3/8	80
AMRS 1207M	12	1/2	80

MTSB - Male Tee Swivel

BSP(P) Thread



PART NO.	Tube O.D. (mm)	BSP(P) Thread	Qty / Box
AMTSB 0402M	4	1/8	450
AMTSB 0404M	4	1/4	350
AMTSB 0502M	5	1/8	300
AMTSB 0504M	5	1/4	250
AMTSB 0602M	6	1/8	250
AMTSB 0604M	6	1/4	200
AMTSB 0802M	8	1/8	200
AMTSB 0804M	8	1/4	150
AMTSB 0806M	8	3/8	150
AMTSB 1004M	10	1/4	130
AMTSB 1006M	10	3/8	100
AMTSB 1007M	10	1/2	100
AMTSB 1206M	12	3/8	80
AMTSB 1207M	12	1/2	80

MTS - Male Tee Swivel

BSPT(PT) Thread



PART NO.	Tube O.D. (mm)	BSPT(PT) Thread	Qty / Box
AMTS 0402M	4	1/8	500
AMTS 0404M	4	1/4	400
AMTS 0502M	5	1/8	300
AMTS 0504M	5	1/4	250
AMTS 0602M	6	1/8	250
AMTS 0802M	8	1/8	200
AMTS 0804M	8	1/4	180
AMTS 0806M	8	3/8	150
AMTS 1004M	10	1/4	130
AMTS 1006M	10	3/8	100
AMTS 1007M	10	1/2	100
AMTS 1206M	12	3/8	70
AMTS 1207M	12	1/2	70

OC - Offset Connector



PART NO.	Tube O.D. (mm)	Tube O.D. (mm)	Qty / Box
AOC 1006M	10	6	200
AOC 1208M	12	8	200

CR - CRoss



PART NO.	Tube O.D.(mm)	Qty / Box
ACR 0404M	4	300
ACR 0606M	6	250
ACR 0808M	8	200
ACR 1010M	10	120
ACR 1212M	12	80

THWD - Three Way Divider



PART NO.	Tube O.D. (mm)	Tube O.D. (mm)	Qty / Box
ATHWD 1006M	10	6	150
ATHWD 1210M	12	10	50

SAB - Stem Adapter

BSP(P) Thread



PART NO.	Stem O.D. (mm)	BSP(P) Thread	Qty / Box
ASAB 0402M	4	1/8	900
ASAB 0404M	4	1/4	600
ASAB 0502M	5	1/8	600
ASAB 0504M	5	1/4	500
ASAB 0602M	6	1/8	500
ASAB 0604M	6	1/4	400
ASAB 0802M	8	1/8	500
ASAB 0804M	8	1/4	400
ASAB 0806M	8	3/8	250
ASAB 1004M	10	1/4	250
ASAB 1006M	10	3/8	250
ASAB 1007M	10	1/2	150
ASAB 1206M	12	3/8	150
ASAB 1207M	12	1/2	150
ASAB 1506M	15	3/8	150
ASAB 1507M	15	1/2	150
ASAB 1807M	18	1/2	100
ASAB 2207M	22	1/2	80
ASAB 2209M	22	3/4	80

TU - Tee Union

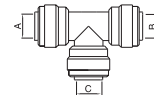

PART NO.	Tube O.D. (A) (mm)	Tube O.D. (B) (mm)	Tube O.D. (C) (mm)	Qty / Box
ATU 040404M	4	4	4	300
ATU 050505M	5	5	5	350
ATU 060606M	6	6	6	300
ATU 080808M	8	8	8	200
ATU 101006M	10	10	6	150
ATU 101010M	10	10	10	150
ATU 121210M	12	12	10	100
ATU 121212M	12	12	12	100
ATU 121012M	12	10	12	100
ATU 151010M	15	10	10	50
ATU 151510M	15	15	10	50
ATU 151512M	15	15	12	50
ATU 151515M	15	15	15	50
ATU 151522M	15	15	22	40
ATU 161616M	16	16	16	40
ATU 161622M	16	16	22	40
ATU 181815M	18	18	15	30
ATU 181816M	18	18	16	30
ATU 181818M	18	18	18	30
ATU 221515M	22	15	22	20
ATU 221522M	22	15	22	20
ATU 222210M	22	22	10	20
ATU 222215M	22	22	15	20
ATU 221616M	22	16	16	20
ATU 222216M	22	22	16	20
ATU 222222M	22	22	22	20
ATU 282815M	28	28	15	10
ATU 282828M	28	28	28	10

SA - Stem Adapter

BSPT(PT) Thread



PART NO.	Stem O.D. (mm)	BSPT(PT) Thread	Qty / Box
ASA 0402M	4	1/8	800
ASA 0404M	4	1/4	500
ASA 0502M	5	1/8	800
ASA 0504M	5	1/4	500
ASA 0602M	6	1/8	500
ASA 0604M	6	1/4	500
ASA 0802M	8	1/8	500
ASA 0804M	8	1/4	400
ASA 0806M	8	3/8	300
ASA 1004M	10	1/4	400
ASA 1006M	10	3/8	300
ASA 1007M	10	1/2	250
ASA 1206M	12	3/8	250
ASA 1207M	12	1/2	150

PART NO.	Tube O.D. (A)	Tube O.D. (B)	Tube O.D. (C)	Qty / Box
ATU 15M0606	15mm	3/8	3/8	50
ATU 1515M06	15mm	15mm	3/8	50
ATU 1616M07	16mm	16mm	1/2	20
ATU 18M0606	18mm	3/8	3/8	20

PART NO.	Tube O.D. (A)	Tube O.D. (B)	Tube O.D. (C)	Tube O.D. (C)	Qty / Box
ATU 1515M0606	15mm	15mm	3/8	3/8	20

BU - Bulkhead Union



PART NO.	Tube O.D. (mm)	Tube O.D. (mm)	Thread Size	Qty / Box
ABU 0404M	4	4	M16XP1	300
ABU 0505M	5	5	M16XP1	300
ABU 0606M	6	6	M16XP1	250
ABU 0610M	6	10	M20XP1.5	200
ABU 0808M	8	8	M20XP1.5	200
ABU 1006M	10	6	M20XP1.5	150
ABU 1010M	10	10	M20XP1.5	150
ABU 1212M	12	12	M27XP1.5	70

UB - U Bend



PART NO.	Tube O.D (mm)	Tube O.D (mm)	Qty / Box
AUB 0606M	6	6	350
AUB 0808M	8	8	250
AUB 1010M	10	10	150
AUB 1212M	12	12	100
AUB 1515M	15	15	60
AUB 1616M	16	16	60
AUB 2222M	22	22	30

ACETAL FITTINGS (BLACK / METRIC)

TWD - Two Way Divider



PART NO.	Tube in (mm)	Tube out (mm)	Qty / Box
ATWD 0404M	4	4	400
ATWD 0606M	6	6	300
ATWD 0808M	8	8	200
ATWD 1008M	10	8	150
ATWD 1010M	10	10	150
ATWD 1012M	10	12	100
ATWD 1212M	12	12	100
ATWD 1515M	15	15	100

New

UC - Union Connector



PART NO.	Tube in (mm)	Tube out (mm)	Qty / Box
AUC 0404M	4	4	500
AUC 0505M	5	5	500
AUC 0604M	6	4	500
AUC 0605M	6	5	400
AUC 0606M	6	6	350
AUC 0804M	8	4	400
AUC 0805M	8	5	300
AUC 0806M	8	6	300
AUC 0808M	8	8	300
AUC 1004M	10	4	300
AUC 1005M	10	5	300
AUC 1006M	10	6	250
AUC 1008M	10	8	250
AUC 1010M	10	10	250
AUC 1208M	12	8	200
AUC 1210M	12	10	150
AUC 1212M	12	12	150
AUC 1510M	15	10	100
AUC 1512M	15	12	100
AUC 1515M	15	15	100
AUC 1612M	16	12	100
AUC 1615M	16	15	100
AUC 1616M	16	16	100
AUC 1818M	18	18	60
AUC 2215M	22	15	50
AUC 2216M	22	16	50
AUC 2222M	22	22	50
AUC 2828M	28	28	40

PART NO.	Tube O.D. (mm)	Tube O.D.	Qty / Box
AUC 15M07	15	1/2	100
AUC 12M06	12	3/8	100

SUC - Swivel Union Connector

BSP(P) Thread



PART NO.	Tube O.D. (mm)	BSP(P) Thread	Qty / Box
ASUC 1507M	15	1/2	80
ASUC 1509M	15	3/4	50
ASUC 1607M	16	1/2	80
ASUC 1609M	16	3/4	50
ASUC 2209M	22	3/4	40

SEU - Swivel Elbow Union

BSP(P) Thread



PART NO.	Tube O.D. (mm)	BSP(P) Thread	Qty / Box
ASEU 1507M	15	1/2	50
ASEU 1509M	15	3/4	50
ASEU 1607M	16	1/2	50
ASEU 1609M	16	3/4	50

TES - Tube End Stop



PART NO.	Tube O.D. (mm)	Qty / Box
ATES 06M	6	800
ATES 08M	8	600
ATES 10M	10	300
ATES 12M	12	200
ATES 15M	15	100
ATES 16M	16	100
ATES 18M	18	50
ATES 22M	22	50

PL - Plug



PART NO.	Stem O.D. (mm)	Qty / Box
APL 04M	4	1000
APL 05M	5	1000
APL 06M	6	1000
APL 08M	8	700
APL 10M	10	500
APL 12M	12	400
APL 15M	15	250
APL 18M	18	250
APL 22M	22	100

TBC - Tube Barb Connector



PART NO.	Stem O.D. (mm)	Tube I.D. (mm)	Qty / Box
ATBC 0604M	6	4	1000
ATBC 0606M	6	6	800
ATBC 0806M	8	6	700
ATBC 1008M	10	8	500
ATBC 1010M	10	10	500
ATBC 1210M	12	10	300

PART NO.	Stem O.D. (mm)	Tube O.D.	Qty / Box
ATBC 15M06	15	3/8	300
ATBC 15M07	15	1/2	300

SSA - Stem to Stem Adapter



PART NO.	Stem O.D. (mm)	Stem O.D.	Qty / Box
ASSA 15M06	15	3/8	200

BBC - BarB Connector



PART NO.	Tube O.D. (mm)	Tube I.D.	Qty / Box
ABBC 1507M	15	1/2	150
ABBC 1607M	16	1/2	150
ABBC 2207M	22	1/2	80
ABBC 2209M	22	3/4	80

PART NO.	Tube O.D. (mm)	Tube I.D. (mm)	Qty / Box
ABBC 1210M	12	10	200
ABBC 1510M	15	10	150
ABBC 1610M	16	10	150

PART NO.	Tube O.D. (mm)	Tube I.D. (mm)	Qty / Box
ABBC 15M09	15	9	150
ABBC 15M10	15	10	150
ABBC 15M13	15	13	150

DA - Drain Adapter

NPSH Thread



PART NO.	Tube O.D. (mm)	NPSH Thread	Qty / Box
ADA 1509M	15	3/4	50
ADA 1609M	16	3/4	50

TC - Tank Connector



PART NO.	Tube O.D. (mm)	Thread Size	Qty / Box
ATC 15M	15	M30XP3.5	30
ATC 22M	22	M39XP3.5	20
ATC 28M	28	M39XP2.0	10

EFCB - Elbow Female Connector

BSP(P) Thread



PART NO.	Tube O.D. (mm)	BSP(P) Thread	Qty / Box
AEFCB 1507M	15	1/2	50

FWC - Four Way Connector



PART NO.	Tube O.D. (mm)	Tube O.D. (mm)	Qty / Box
AFWC 2210M	22	10	50

SFCB - Straight Female Connector

BSP(P) Thread



PART NO.	Tube O.D. (mm)	BSP(P) Thread	Qty / Box
ASFCB 1507M	15	1/2	50
ASFCB 1509M	15	3/4	50
ASFCB 2209M	22	3/4	40

Special design



- The unique oval-shaped collet is easier to grip, facilitating connecting and disconnecting.
- The rounded stainless teeth minimize scratches on the tube, allowing more frequent re-use.

PACKAGING - PALLET AND BOX SIZES

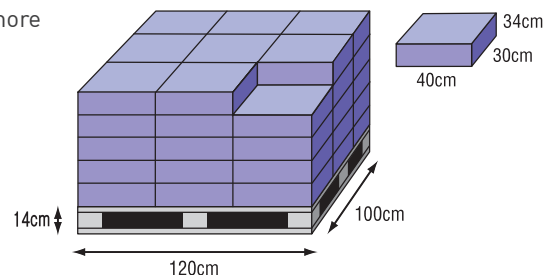

ACETAL POWER FITTINGS (GRAY-INCH / BLACK-METRIC)

for use with Stainless Steel Pipe

Structure

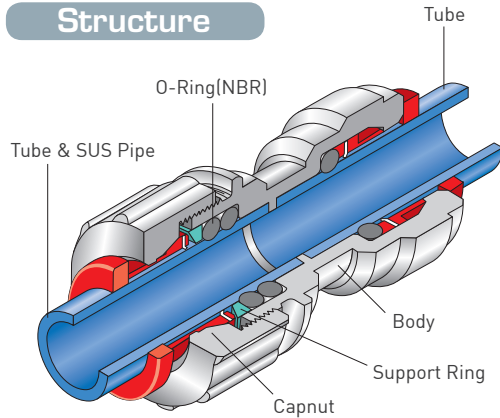

■ Features

- This is the special products using for stainless steel, or other plated pipes.
- When you fasten 'cap nut', interaction between Support Ring and Collet can grab more completely the pipe, and seal O-Ring in the fitting.
- Two O-Rings give more sealing effectiveness in the high temperature.
- It prevents a breakaway of pipe from fastening 'cap nut' with using hands tools.

PSEU - Power Elbow Union (Single)



PART NO.	Tube O.D.	Power O.D.	Qty / Box
APSEU 0505	5/16	5/16	250
APSEU 0506	5/16	3/8	250
APSEU 0604	3/8	1/4	300
APSEU 0605	3/8	5/16	200
APSEU 0606	3/8	3/8	200

PBEU - Power Elbow Union (Both)



PART NO.	Power O.D.	Power O.D.	Qty / Box
APBEU 0505	5/16	5/16	250
APBEU 0605	3/8	5/16	250
APBEU 0606	3/8	3/8	200

PSUC - Power Union Connector (Single)



PART NO.	Tube O.D.	Power O.D.	Qty / Box
APSUC 0505	5/16	5/16	300
APSUC 0506	5/16	3/8	250
APSUC 0604	3/8	1/4	250
APSUC 0605	3/8	5/16	200
APSUC 0606	3/8	3/8	200

PBUC - Power Union Connector (Both)



PART NO.	Power O.D.	Power O.D.	Qty / Box
APBUC 0505	5/16	5/16	250
APBUC 0606	3/8	3/8	250

PMCBT - Power Male Connector

BSPT(PT) Thread



PART NO.	Power O.D.	BSPT(PT) Thread	Qty / Box
APMCBT 0504	5/16	1/4	400

PSP - Power SPanner (Nylon)



PART NO.	Tube O.D.
NPSP	5/16, 3/8

- Available in metallic spanner

PSFBU - Power Flow Bend Union (Single)



PART NO.	Power O.D.	Tube O.D.	Qty / Box
APSFBU 0505	5/16	5/16	

PMCF - Power Male Connector

MFL Thread



PART NO.	Power O.D.	MFL Thread	Qty / Box
APMCF 0504	5/16	1/4	400
APMCF 0506	5/16	3/8	250

- 7/16-20 UNF corresponds to a 1/4 MFL
- 5/8-18 UNF corresponds to a 3/8 MFL

PBBC - Power BarB Connector



PART NO.	Power O.D.	Tube I.D.	Qty / Box
APBBC 0404	1/4	1/4	400
APBBC 0504	5/16	1/4	400
APBBC 0604	3/8	1/4	250

PMCBT - Power Male Connector

BSPT(PT) Thread



PART NO.	Power O.D. (mm)	BSPT(PT) Thread	Qty / Box
APMCBT 0804M	8	1/4	400

PSEU - Power Elbow Union (Single)



PART NO.	Tube O.D. (mm)	Power O.D. (mm)	Qty / Box
APSEU 0808M	8	8	250
APSEU 0810M	8	10	250
APSEU 1006M	10	6	300
APSEU 1008M	10	8	250
APSEU 1010M	10	10	250

PBEU - Power Elbow Union (Both)



PART NO.	Power O.D. (mm)	Power O.D. (mm)	Qty / Box
APBEU 0808M	8	8	250
APBEU 1008M	10	8	250
APBEU 1010M	10	10	250

PSUC - Power Union Connector (Single)



PART NO.	Tube O.D. (mm)	Power O.D. (mm)	Qty / Box
APSUC 0808M	8	8	300
APSUC 0810M	8	10	250
APSUC 1006M	10	6	250
APSUC 1008M	10	8	250
APSUC 1010M	10	10	250

PBUC - Power Union Connector (Both)



PART NO.	Power O.D. (mm)	Power O.D. (mm)	Qty / Box
APBUC 0808M	8	8	250
APBUC 1010M	10	10	250

PMCW - Power Male Connector

BSW Thread



PART NO.	Power O.D. (mm)	BSW Thread	Qty / Box
APMCW 08 9/16M	8	9/16-24	400
APMCW 10 9/16M	10	9/16-24	350

PMCF - Power Male Connector

MFL Thread



PART NO.	Power O.D. (mm)	MFL Thread	Qty / Box
APMCF 0804M	8	1/4	40
APMCF 0806M	8	3/8	350

- 7/16-20 UNF corresponds to a 1/4 MFL
- 5/8-18 UNF corresponds to a 3/8 MFL

CLEAN FITTINGS (GRAY / INCH)

Structure

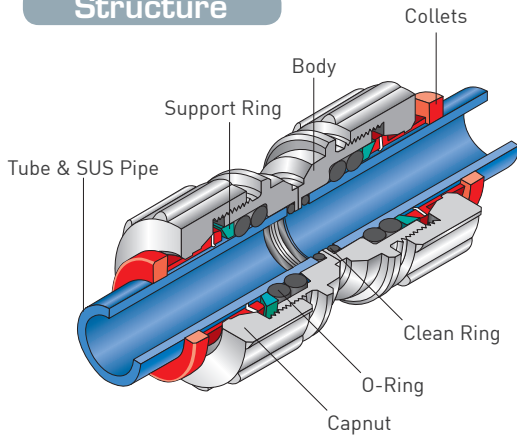

■ Features

- Designed to no gap between pipe and clean ring, there is no movement of the pipe.
- This function prevents the containment, and provides to use the clean environments.
- Clean fittings are conducted the same function as power fittings and with EPDM O-rings.

CIMCBT - Clean fitting Male Connector BSPT(PT)Thread



PART NO.	Power O.D.	BSPT(PT) Thread	Qty / Box
ACIMCBT 0504	5/16	1/4	400

CIBEU - Clean fitting Elbow Union (Both)



PART NO.	Power O.D.	Power O.D.	Qty / Box
ACIBEU 0505	5/16	5/16	250
ACIBEU 0605	3/8	5/16	250
ACIBEU 0606	3/8	3/8	250

CIBUC - Clean fitting Union Connector (Both)



PART NO.	Power O.D.	Power O.D.	Qty / Box
ACIBUC 0505	5/16	5/16	250
ACIBUC 0606	3/8	3/8	250

CIMCW - Clean fitting Male Connector BSW Thread



PART NO.	Power O.D.	BSW Thread	Qty / Box
ACIMCW 05 9/16	5/16	9/16-24	400
ACIMCW 06 9/16	3/8	9/16-24	350

CIMCF - Clean fitting Male Connector MFL Thread



PART NO.	Power O.D.	MFL Thread	Qty / Box
ACIMCF 0504	5/16	1/4	400
ACIMCF 0506	5/16	3/8	350

- 7/16-20 UNF corresponds to a 1/4 MFL
- 5/8-18 UNF corresponds to a 3/8 MFL

POLYPROPYLENE FITTINGS (WHITE / INCH)



■ Suitable for

- **Water & foods use :** *DMfit*[®] products are manufactured from safe, non-toxic materials meeting the requirements of the US FDA, WRAS, ANSI/NSF-51, 61, and SK Zert. Our products are widely used in water purification, food/beverage.
- **Function & Quality :** *DMfit*[®] provides quick and convenient assembly - saving time & expense. Our ISO9001, 14001 registered quality system ensures our customers a superior level of product quality. Defects are easily detectable and maintenance is easy with its easy dismantling for access.
- **Collet Design :** Our unique oval collet design is superior and more practical, and is an improvement welcomed by our world-wide customers in all industries.
- **Applications :** Beyond water and food use, fittings can be used with air, gases, vacuum, & liquids. And all connections can be assembled & disassembled repeatedly. A broad of sizes covers a broad scope of applications.
- **Color :** White Polypropylene with food grade EPDM O-rings.

Working Pressure and Temperature

Pressure	10bar	4bar
Temperature	1 °C (35°F) ~ 20 °C (70°F)	65 °C (150°F)

MC - Male Connector



PART NO.	Tube O.D.	NPTF Thread	
		NPTF Thread	Qty / Box
PMC 0402W	1/4	1/8	400
PMC 0404W	1/4	1/4	350
PMC 0406W	1/4	3/8	300
PMC 0407W	1/4	1/2	150
PMC 0502W	5/16	1/8	400
PMC 0504W	5/16	1/4	400
PMC 0506W	5/16	3/8	350
PMC 0602W	3/8	1/8	300
PMC 0604W	3/8	1/4	300
PMC 0606W	3/8	3/8	250
PMC 0607W	3/8	1/2	200
PMC 0706W	1/2	3/8	200
PMC 0707W	1/2	1/2	150
PMC 0807W	5/8	1/2	80
PMC 1009W	7/8	3/4	40

MCB - Male Connector



PART NO.	Tube O.D.	BSP(P) Thread	
		BSP(P) Thread	Qty / Box
PMCB 0807W	5/8	1/2	100
PMCB 0809W	5/8	3/4	100
PMCB 1009W	7/8	3/4	50

New

ME - Male Elbow



PART NO.	Tube O.D.	NPTF Thread	
		NPTF Thread	Qty / Box
PME 0402W	1/4	1/8	500
PME 0404W	1/4	1/4	350
PME 0406W	1/4	3/8	300
PME 0504W	5/16	1/4	300
PME 0506W	5/16	3/8	300
PME 0604W	3/8	1/4	250
PME 0606W	3/8	3/8	250
PME 0706W	1/2	3/8	200
PME 0707W	1/2	1/2	150

EU - Elbow Union



PART NO.	Tube O.D.	Tube O.D.	Qty / Box
PEU 0404W	1/4	1/4	350
PEU 0504W	5/16	1/4	300
PEU 0505W	5/16	5/16	300
PEU 0604W	3/8	1/4	200
PEU 0605W	3/8	5/16	200
PEU 0606W	3/8	3/8	200
PEU 0704W	1/2	1/4	150
PEU 0705W	1/2	5/16	150
PEU 0706W	1/2	3/8	150
PEU 0707W	1/2	1/2	150
PEU 1008W	7/8	5/8	50

POLYPROPYLENE FITTINGS (WHITE / INCH)

TU - Tee Union

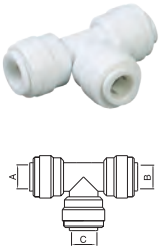

PART NO.	Tube O.D. (A)	Tube O.D. (B)	Tube O.D. (C)	Qty / Box
PTU 010101W	5/32	5/32	5/32	350
PTU 030303W	3/16	3/16	3/16	350
PTU 040404W	1/4	1/4	1/4	300
PTU 050505W	5/16	5/16	5/16	200
PTU 060604W	3/8	3/8	1/4	150
PTU 060606W	3/8	3/8	3/8	150
PTU 070706W	1/2	1/2	3/8	100
PTU 070707W	1/2	1/2	1/2	100
PTU 080804W	5/8	5/8	1/4	50
PTU 080807W	5/8	5/8	1/2	50
PTU 080808W	5/8	5/8	5/8	40
PTU 080810W	5/8	5/8	7/8	40
PTU 100810W	7/8	5/8	7/8	30
PTU 101008W	7/8	7/8	5/8	30
PTU 100808W	7/8	5/8	5/8	40
PTU 101010W	7/8	7/8	7/8	30

TTU - Tube Tee Union connector



PART NO.	Tube O.D.	Tube O.D.	Stem O.D.	Qty / Box
PTTU 080808W	5/8	5/8	5/8	50

New

FAB - Female Adapter



PART NO.	Tube O.D.	BSP(P) Thread	Qty / Box
PFAB 0406CW	1/4	3/8	250
PFAB 0407CW	1/4	1/2	200
PFAB 0506CW	5/16	3/8	200
PFAB 0507CW	5/16	1/2	200
PFAB 0606CW	3/8	3/8	200
PFAB 0607CW	3/8	1/2	200
PFAB 0608CW	3/8	5/8	150
PFAB 0708CW	1/2	5/8	150

BSP(P) Thread (Cone Type)

New

FA - Female Adapter



PART NO.	Tube O.D.	NPTF Thread	Qty / Box
PFA 0402W	1/4	1/8	400
PFA 0404W	1/4	1/4	400
PFA 0502W	5/16	1/8	300
PFA 0504W	5/16	1/4	300
PFA 0602W	3/8	1/8	300
PFA 0604W	3/8	1/4	300
PFA 0807W	5/8	1/2	100
PFA 0809W	5/8	3/4	100
PFA 1009W	7/8	3/4	50
PFA 1011W	7/8	1	40

NPTF Thread

New

FAB - Female Adapter



PART NO.	Tube O.D.	BSP(P) Thread	Qty / Box
PFAB 0508FW	5/16	5/8	250
PFAB 0607FW	3/8	1/2	200
PFAB 0608FW	3/8	5/8	150
PFAB 0706FW	1/2	3/8	200
PFAB 0707FW	1/2	1/2	150
PFAB 0708FW	1/2	5/8	150

BSP(P) Thread (Flat Type)

New

FAUF - Female Adapter



PART NO.	Tube O.D.	UNF Thread	Qty / Box
PFAUF 04 7/16CW	1/4	7/16 - 20	400
PFAUF 05 7/16CW	5/16	7/16 - 20	350
PFAUF 06 7/16CW	3/8	7/16 - 20	300

UNF Thread (Cone Type)

New

FAU - Female Adapter



PART NO.	Tube O.D.	UNS Thread	Qty / Box
PFAU 04 7/16CW	1/4	7/16 - 24	400
PFAU 05 7/16CW	5/16	7/16 - 24	350
PFAU 06 7/16CW	3/8	7/16 - 24	300

UNS Thread (Cone Type)

FAUF - Female Adapter



PART NO.	Tube O.D.	UNF Thread	Qty / Box
PFAUF 04 7/16VW	1/4	7/16 - 20	400
PFAUF 05 7/16VW	5/16	7/16 - 20	300
PFAUF 06 7/16VW	3/8	7/16 - 20	300
PFAUF 06 5/8VW	3/8	5/8 - 18	350

UNF Thread (V - Type)

New

FAUN - Female Adapter



PART NO.	Tube O.D.	UN Thread	Qty / Box
PFAUN 05 1/2VW	5/16	1/2 - 16	350
PFAUN 06 1/2VW	3/8	1/2 - 16	200
PFAUN 07 1/2VW	1/2	1/2 - 16	150

UN Thread (V - Type)

New

- 7/16 UNF Corresponds to a 1/4 MFL
- 5/8 UNF Corresponds to a 3/8 MFL

HA - Hub Adapter



NPSH Thread

New

PART NO.	Tube O.D.	NPSH Thread	Qty / Box
PHA 1011W	7/8	1	400

DA - Drain Adapter



NPSH Thread

New

PART NO.	Tube O.D.	NPSH Thread	Qty / Box
PDA 0809W	5/8	3/4	50

SA - Stem Adapter



NPTF Thread

PART NO.	Stem O.D.	NPTF Thread	Qty / Box
PSA 0102W	5/32	1/8	800
PSA 0104W	5/32	1/4	500
PSA 0302W	3/16	1/8	800
PSA 0402W	1/4	1/8	500
PSA 0404W	1/4	1/4	500
PSA 0502W	5/16	1/8	500
PSA 0504W	5/16	1/4	400
PSA 0506W	5/16	3/8	300
PSA 0604W	3/8	1/4	300
PSA 0606W	3/8	3/8	300
PSA 0706W	1/2	3/8	250
PSA 0707W	1/2	1/2	150

BU - Bulkhead Union



New

PART NO.	Tube O.D.	Tube O.D.	Thread Size	Qty / Box
PBU 0101W	5/32	5/32	M16XP1	300
PBU 0303W	3/16	3/16	M16XP1	300
PBU 0404W	1/4	1/4	M16XP1	250
PBU 0406W	1/4	3/8	M20XP1.5	200
PBU 0505W	5/16	5/16	M20XP1.5	150
PBU 0604W	3/8	1/4	M20XP1.5	150
PBU 0606W	3/8	3/8	M20XP1.5	150
PBU 0707W	1/2	1/2	M27XP1.5	70

SABT - Stem Adapter



BSPT(PT) Thread

New

PART NO.	Stem O.D.	BSPT(PT) Thread	Qty / Box
PSABT 0302W	3/16	1/8	800
PSABT 0504W	5/16	1/4	400
PSABT 0506W	5/16	3/8	300
PSABT 0604W	3/8	1/4	400
PSABT 0606W	3/8	3/8	300
PSABT 0707W	1/2	1/2	150

CR - CROSS



New

PART NO.	Tube O.D.	Qty / Box
PCR 0101W	5/32	300
PCR 0404W	1/4	250
PCR 0505W	5/16	200
PCR 0606W	3/8	100
PCR 0707W	1/2	80

THWD - Three Way Divider



New

PART NO.	Tube O.D.	Tube O.D.	Qty / Box
PTHWD 0604W	3/8	1/4	150
PTHWD 0706W	1/2	3/8	50

UC - Union Connector



PART NO.	Tube O.D.	Tube O.D.	Qty / Box
PUC 0101W	5/32	5/32	500
PUC 0303W	3/16	3/16	500
PUC 0404W	1/4	1/4	350
PUC 0501W	5/16	5/32	400
PUC 0503W	5/16	3/16	400
PUC 0504W	5/16	1/4	300
PUC 0505W	5/16	5/16	300
PUC 0603W	3/8	3/16	300
PUC 0604W	3/8	1/4	250
PUC 0605W	3/8	5/16	250
PUC 0606W	3/8	3/8	250
PUC 0705W	1/2	5/16	200
PUC 0706W	1/2	3/8	200
PUC 0707W	1/2	1/2	150
PUC 067.5W	3/8	7.5 (mm)	250
PUC 0807W	5/8	1/2	100
PUC 0808W	5/8	5/8	100
PUC 1008W	7/8	5/8	50
PUC 1010W	7/8	7/8	50

TEU - Tube Elbow Union



PART NO.	Tube O.D.	Stem O.D.	Qty / Box
PTEU 0101W	5/32	5/32	800
PTEU 0303W	3/16	3/16	600
PTEU 0306W	3/16	3/8	500
PTEU 0404W	1/4	1/4	500
PTEU 0406W	1/4	3/8	400
PTEU 0505W	5/16	5/16	350
PTEU 0506W	5/16	3/8	350
PTEU 0606W	3/8	3/8	250
PTEU 0607W	3/8	1/2	200
PTEU 0707W	1/2	1/2	150
PTEU 0808W	5/8	5/8	50
PTEU 1010W	7/8	7/8	50

POLYPROPYLENE FITTINGS (WHITE / INCH)

TES - Tube End Stop

New



PART NO.	Tube O.D.	Qty / Box
PTES 04W	1/4	800
PTES 05W	5/16	600
PTES 06W	3/8	300
PTES 07W	1/2	300
PTES 08W	5/8	100
PTES 10W	7/8	50

PL - PLug



PART NO.	Stem O.D.	Qty / Box
PPL 01W	5/32	1000
PPL 03W	3/16	1000
PPL 04W	1/4	1000
PPL 05W	5/16	700
PPL 06W	3/8	500
PPL 07W	1/2	400
PPL 08W	5/8	200
PPL 10W	7/8	100

SUC - Swivel Union Connector

BSP(P) Thread



PART NO.	Tube O.D.	BSP(P) Thread	Qty / Box
PSUC 0807W	5/8	1/2	50
PSUC 0809W	5/8	3/4	50
PSUC 1009W	7/8	3/4	40

SEU - Swivel Elbow Union

BSP(P) Thread

New



PART NO.	Tube O.D.	BSP(P) Thread	Qty / Box
PSEU 0807W	5/8	1/2	50
PSEU 0809W	5/8	3/4	50

TWD - Two Way Divider



PART NO.	Tube in	Tube out	Qty / Box
PTWD 0101W	5/32	5/32	400
PTWD 0404W	1/4	1/4	300
PTWD 0505W	5/16	5/16	200
PTWD 0605W	3/8	5/16	150
PTWD 0606W	3/8	3/8	150
PTWD 0607W	3/8	1/2	100
PTWD 0707W	1/2	1/2	100

KFA - Kitchen Faucet Adapter

NPSM Thread

New



PART NO.	Tube O.D.	NPSM Thread	Qty / Box
PKFA 0407W	1/4	1/2-14	100
PKFA 0607W	3/8	1/2-14	100

- For installing undercounter filters & RO systems



UB - U Bend

New



PART NO.	Tube O.D.	Tube O.D.	Qty / Box
PUB 0404W	1/4	1/4	350
PUB 0505W	5/16	5/16	250
PUB 0606W	3/8	3/8	150
PUB 0707W	1/2	1/2	100
PUB 0808W	5/8	5/8	60
PUB 1010W	7/8	7/8	40

SVA - Stop Valve Adapter

UNEF Thread

New



PART NO.	Tube O.D.	UNEF Thread	Qty / Box
PSVA 04 9/16W	1/4	9/16-24	200
PSVA 06 9/16W	3/8	9/16-24	150

- For an undercounter filter systems



MTU - Male Tee Union

NPTF Thread

New



PART NO.	Tube O.D.	NPTF Thread	Qty / Box
PMTU 0404W	1/4	1/4	300

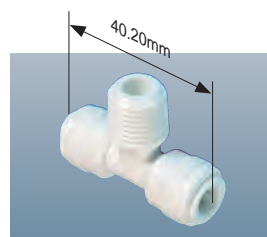

RD - ReDucer



PART NO.	Tube O.D.	Stem O.D.	Qty / Box
PRD 0405W	1/4	5/16	700
PRD 0406W	1/4	3/8	500
PRD 0408W	1/4	5/8	300
PRD 0506W	5/16	3/8	400
PRD 0507W	5/16	1/2	300
PRD 0607W	3/8	1/2	300

TBC - Tube Barb Connector

New



PART NO.	Stem O.D.	Tube I.D.	Qty / Box
PTBC 0404W	1/4	1/4	1000
PTBC 0405W	1/4	5/16	800
PTBC 0504W	5/16	1/4	800
PTBC 0505W	5/16	5/16	700
PTBC 0506W	5/16	3/8	700
PTBC 0604W	3/8	1/4	500
PTBC 0605W	3/8	5/16	500
PTBC 0606W	3/8	3/8	400
PTBC 0607W	3/8	1/2	300
PTBC 0706W	1/2	3/8	300
PTBC 0707W	1/2	1/2	300

STOP & FAUCET ADAPTOR VALVES

Lead Free

AV range of Stop & Faucet Valve Adaptor valves and Slip Tee Valves are manufactured in white Polypropylene, reinforced plastic with EPDM O-rings which provides value-added advantages in the installation of water supply line mainly.

AV range of Stop & Faucet Valve Adaptors and Slip Tee Valves are designed for use in drinking water systems, Refrigerators, Ice-Makers, Humidifiers and Water filtration applications, etc.,. Our valves offer greater efficiency than any traditional valves.

AV valves have been approved in NSF/ANSI 61 & 372.

AV range is 1/4" Turn valves.

Working Pressure and Temperature

Pressure	12bar	6bar
Temperature	20°C (70°F)	65°C (150°F)

STOP VALVE ADAPTOR _ Hand Tighten

New



PART NO	TUBE OD	THREAD	Qty / Box
AVA6753CP	1/4"	3/8" x 3/8" Compression	70
AVA6713CP	3/8"	3/8" x 3/8" Compression	70
AVA6753CPB	1/4"	3/8" x 3/8" BSPP	70
AVA6713CPB	3/8"	3/8" x 3/8" BSPP	70

STOP VALVE ADAPTOR _ Brass Shaft

New



PART NO	TUBE OD	THREAD	Qty / Box
AVA6753BCP	1/4"	3/8" x 3/8" Compression	70
AVA6713BCP	3/8"	3/8" x 3/8" Compression	70
AVA6753BB	1/4"	3/8" x 3/8" BSPP	70
AVA6713BB	3/8"	3/8" x 3/8" BSPP	70



* Conversion adaptor can be threaded to 1/2" x 1/2" NPS/BSPP or 3/8" x 3/8" Compression/BSPP

How to Connect



- ① Shut off your existing Stop valve and disconnect the riser from the valve.
- ② Connect our Stop valve to the water valve.
- ③ Connect the riser to our valve.
- ④ Ensure the Perfect Connection Every Time. Open valves and check for leaks.

New

FAUCET VALVE ADAPTOR _ Hand Tighten



PART NO	TUBE OD	THREAD	Qty / Box
AVA6754	1/4"	1/2" x 1/2" NPS	50
AVA6714	3/8"	1/2" x 1/2" NPS	50
AVA6754BP	1/4"	1/2" x 1/2" BSPP	50
AVA6714BP	3/8"	1/2" x 1/2" BSPP	50

SLIP TEE VALVE

Easy connection with your existing water line – Slip connection
Designed to be suitable for Copper, PEX and CPVC pipe.

5" Long

New



PART NO	TUBE OD	TUBE OD BRANCH	Qty / Box
AVT67665S	5/8" x 5/8"	1/4"	25
AVT67661S	5/8" x 5/8"	3/8"	25
AVT67445S	7/8" x 7/8"	1/4"	25
AVT67665SM	15mm x 15mm	1/4"	25
AVT67661SM	15mm x 15mm	3/8"	25
AVT67445SM	22mm x 22mm	1/4"	25

Angle Check Valve



New

PART NO	TUBE OD	THREAD	Qty / Box
CVA54B	1/4"	1/2" x 1/2" NPS	50
CVA14B	3/8"	1/2" x 1/2" NPS	50
CVA53BB	1/4"	3/8" x 3/8" BSPP	50
CVA13BB	3/8"	3/8" x 3/8" BSPP	50
CVA54BBP	1/4"	1/2" x 1/2" BSPP	50
CVA14BBP	3/8"	1/2" x 1/2" BSPP	50

ICE Maker / Water Supply Kit

New



PART NO	BAG / QTY	Qty / Box
DIK-T (Clear)	1	20
DIK-W (White)	1	20
DIK-B (Blue)	1	20

Contains : (1) 25ft 1/4" PE-RT Tubing, (1) 1/4" Stop Valve, (1) 1/4" Female Adaptor



VALVES (WHITE / INCH)

Control Valves

■ Features

- Highly durable and fatigue resistant.
- Can be used with a variety of chemicals & gases. However, when using other than water or air, please refer to the Chemical Compatibility Tables, or consult our representative.
- Do not apply excessive vibration, torque, shock, or other strong loads on the fittings. The valve body may be damaged or collects may be dislocated.
- Color : Inch Size - White Acetal Copolymer
Metric Size - Black Acetal Copolymer

Working Pressure and Temperature

Pressure	10bar	4bar
Temperature	1°C(35°F) ~ 20°C(70°F)	65°C(150°F)



Flow Rate Per Rotation of Valve Stem

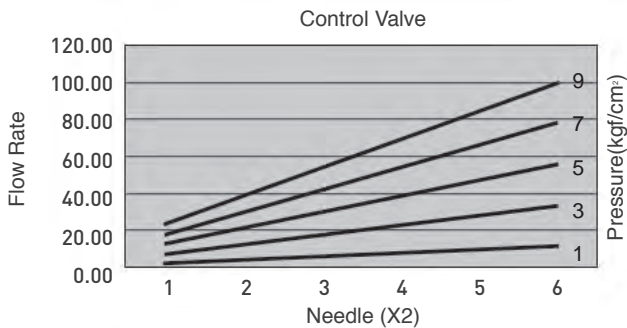

※ Above data may vary depending on the time and temperature variations.

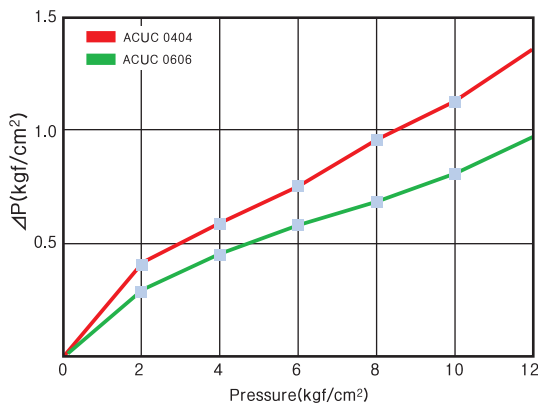

Structure

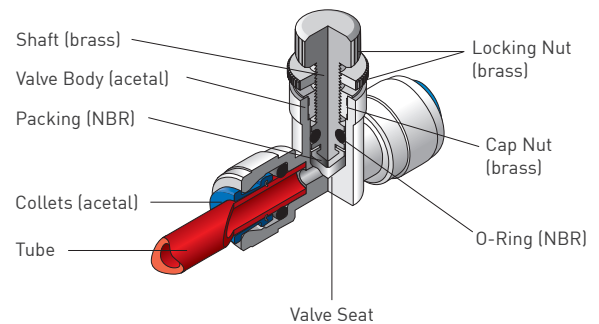

Assembly

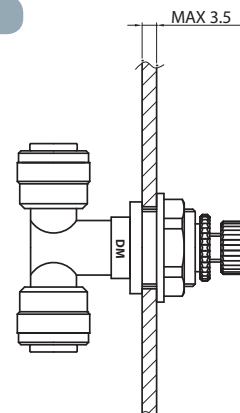

CUC - Control valve Union Connector



PART NO.	Tube O.D.	Tube O.D.	Qty / Box
ACUC 0404	1/4	1/4	250
ACUC 0606	3/8	3/8	150
PART NO.	Tube O.D. (mm)	Tube O.D. (mm)	Qty / Box
ACUC 0606M	6	6	200
ACUC 1010M	10	10	150

CFA - Control valve Female Adapter



PART NO.	Tube O.D.	NPTF Thread	Qty / Box
ACFA 0404	1/4	1/4	250
ACFA 0606	3/8	3/8	150
PART NO.	Tube O.D. (mm)	BSPT(PT) Thread	Qty / Box
ACFA 0604M	6	1/4	200
ACFA 1006M	10	3/8	150

CEU - Control valve Elbow Union



PART NO.	Tube O.D.	Tube O.D.	Qty / Box
ACEU 0404	1/4	1/4	250
ACEU 0606	3/8	3/8	150
PART NO.	Tube O.D. (mm)	Tube O.D. (mm)	Qty / Box
ACEU 0606M	6	6	250
ACEU 1010M	10	10	150

CMC - Control valve Male Connector



PART NO.	Tube O.D.	NPTF Thread	Qty / Box
ACMC 0404	1/4	1/4	250
ACMC 0606	3/8	3/8	150
PART NO.	Tube O.D. (mm)	BSPT(PT) Thread	Qty / Box
ACMC 0604M	6	1/4	250
ACMC 1006M	10	3/8	150

BCUC-Bulkhead Control valve union Connector

New



PART NO.	Tube O.D.	Tube O.D.	Qty / Box
ABCUC 0404	1/4	1/4	200
ABCUC 0606	3/8	3/8	120
PART NO.	Tube O.D. (mm)	Tube O.D. (mm)	Qty / Box
ABCUC 0606M	6	6	150
ABCUC 1010M	10	10	120

BCFA-Bulkhead Control valve Female Adapter

New



PART NO.	Tube O.D.	Tube O.D.	Qty / Box
ABCFA 0404	1/4	1/4	200
ABCFA 0606	3/8	3/8	120
PART NO.	Tube O.D. (mm)	Tube O.D. (mm)	Qty / Box
ABCFA 0604M	6	1/4	150
ABCFA 1010M	10	3/8	120

BCEU-Bulkhead Control valve Elbow Union

New



PART NO.	Tube O.D.	Tube O.D.	Qty / Box
ABCEU 0404	1/4	1/4	200
ABCEU 0606	3/8	3/8	120
PART NO.	Tube O.D. (mm)	Tube O.D. (mm)	Qty / Box
ABCEU 0606M	6	6	150
ABCEU 1010M	10	10	120

BCMC-Bulkhead Control valve Male Connector

New



PART NO.	Tube O.D.	Tube O.D.	Qty / Box
ABCMC 0404	1/4	1/4	200
ABCMC 0606	3/8	3/8	120
PART NO.	Tube O.D. (mm)	Tube O.D. (mm)	Qty / Box
ABCMC 0604M	6	1/4	150
ABCMC 1010M	10	3/8	120

VALVES (WHITE / INCH)

Hand Valves

■ Features



- Can be used with a variety of chemicals & gases. However, when using other than water or air, please refer to the Chemical Compatibility Tables or consult our representative.
- Do not apply excessive vibration, torque, shock, or other strong loads on the fittings. The valve body may be damaged, or the

collets may be dislocated.

- Easy quarter-turn operation for opening and closing.
- Partial flow control is possible (high, medium, low).
- Ruggedly designed for durability.
- Color : Inch Size - White, Metric Size - Black
- Max. Handle Torque : 0.2 N-M

Working Pressure and Temperature

	Temperature	Pressure
Air	-20°C	10bar
Air / Liquid	1°C	10bar
	20°C	10bar
	65°C	7bar

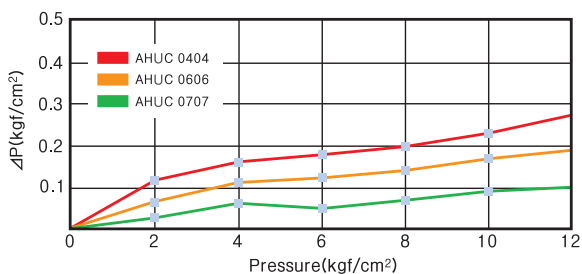

Structure

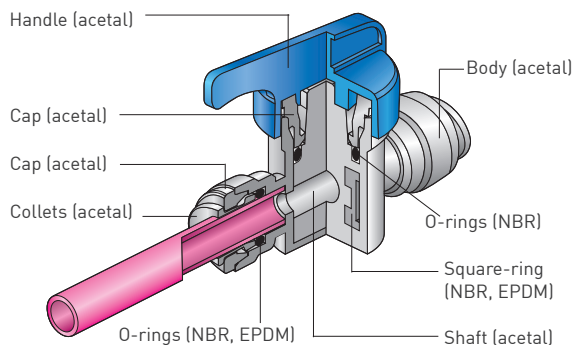

HMC - Hand valve Male Connector



PART NO.	Tube O.D.	NPTF Thread	Qty / Box
AHMC 0404	1/4	1/4	150
AHMC 0606	3/8	3/8	100
AHMC 0707	1/2	1/2	70

HUC - Hand valve Union Connector



Fitting Size	PART NO.	Tube O.D.	Tube O.D.	Qty / Box
Small Size	AHUC 0404	1/4	1/4	150
	AHUC 0505	5/16	5/16	100
	AHUC 0606	3/8	3/8	100
	AHUC 0707	1/2	1/2	70
Large Size	AHUC 0806	5/8	3/8	50
	AHUC 0807	5/8	1/2	50
	AHUC 0808	5/8	5/8	40
	AHUC 1010	7/8	7/8	20

HFA - Hand valve Female Adapter



Fitting Size	PART NO.	Tube O.D.	NPTF Thread	Qty / Box
Small Size	AHFA 0404	1/4	1/4	100
	AHFA 0604	3/8	1/4	100
	AHFA 0606	3/8	3/8	100
	AHFA 0607	3/8	1/2	80
	AHFA 0706	1/2	3/8	70
	AHFA 0707	1/2	1/2	70
Large Size	AHFA 0806	5/8	3/8	40
	AHFA 0807	5/8	1/2	50

HFAUC - Hand valve Female Adapter Union Connector



PART NO.	Tube O.D.	NPTF Thread	Qty / Box
AHFAUC 0607	3/8	1/2	100

PART NO.	Tube O.D. (mm)	BSPT(PT) Thread	Qty / Box
AHFAUC 1007M	10	1/2	100

Hand Valves

HUCS - Hand valve Union Connector (Short handle)

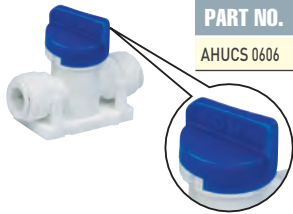

PART NO.	Tube O.D.	Tube O.D.	Qty / Box
AHUCS 0606	3/8	3/8	100

※ Order sizes with short handle are available by customer's demand.

HWM - Hand Washing Machine valve



PART NO.	Tube O.D.	BSP(T) Thread	Thread Size	Qty / Box
AHWM 0809	5/8	3/4	M3.0XP3.5	20

MCLP - Mounting Clip



PART NO.	Size	Qty / Box
AMCLP06	3/8	200

TWV - Three Way Valve



PART NO.	Tube O.D.	Tube O.D.	Tube O.D.	Qty / Box
ATWV 080808	5/8	5/8	5/8	20

HVEU - Hand Valve Elbow Union connector



PART NO.	Tube O.D.	Tube O.D.	Qty / Box
AHVEU 0608	3/8	5/8	50

HBC - Hand Barb Connector



PART NO.	Tube O.D.	Tube I.D.	Qty / Box
AHBC 0807	5/8	1/2	100
AHBC 1007	7/8	1/2	60
AHBC 1009	7/8	3/4	60

VALVES (BLACK / METRIC)

Hand Valves

HMC - Hand valve Male Connector



PART NO.	Tube O.D. (mm)	BSP(PT) Thread	Qty / Box
AHMC 0604M	6	1/4	150
AHMC 1006M	10	3/8	100
AHMC 1207M	12	1/2	70

HVMCB - Hand Valve Male Connector

BSP(P) Thread



PART NO.	Tube O.D.(mm)	BSP(P) Thread	Qty / Box
AHVMCB 1509M	15	3/4	30

HUC - Hand valve Union Connector



Fitting Size	PART NO.	Tube O.D. (mm)	Tube O.D. (mm)	Qty / Box
Small Size	AHUC 0606M	6	6	150
	AHUC 0808M	8	8	100
	AHUC 1010M	10	10	100
	AHUC 1212M	12	12	70
Large Size	AHUC 1510M	15	10	50
	AHUC 1512M	15	12	50
	AHUC 1515M	15	15	40
	AHUC 1610M	16	10	50
	AHUC 1616M	16	16	40
	AHUC 2222M	22	22	20



Fitting Size	PART NO.	Tube O.D. (mm)	Tube O.D.	Qty / Box
Large Size	AHUC 16M06	15	3/8	40
	AHUC 16M07	15	1/2	40
	AHUC 16M08	15	5/8	50

HFA - Hand valve Female Adapter



Fitting Size	PART NO.	Tube O.D. (mm)	BSP(PT) Thread	Qty / Box
Small Size	AHFA 0604M	6	1/4	150
	AHFA 1006M	10	3/8	100
	AHFA 1007M	10	1/2	100
	AHFA 1206M	12	3/8	70
	AHFA 1207M	12	1/2	70
Large Size	AHFA 1506M	15	3/8	40
	AHFA 1507M	15	1/2	40
	AHFA 1606M	16	3/8	40
	AHFA 1607M	16	1/2	40



TWV - Three Way Valve



PART NO.	Tube O.D. (mm)	Tube O.D. (mm)	Tube O.D. (mm)	Qty / Box
ATWV 121212M	12	12	12	20



PART NO.	Tube O.D. (mm)	Tube O.D. (mm)	Tube O.D. (mm)	Qty / Box
ATWV 161616M	16	16	16	20

HBC - Hand Barb Connector



PART NO.	Tube O.D. (mm)	Tube I.D.	Qty / Box
AHBC 1507M	15	1/2	100
AHBC 2107M	21	1/2	60
AHBC 2109M	21	3/4	50
AHBC 2207M	22	1/2	60
AHBC 2209M	22	3/4	50

HSV - Hand Stop Valve connector



PART NO.	Tube O.D.(mm)	Tube O.D.(mm)	Qty / Box
AHSV 1515M	15	15	80
AHSV 2115M	21	15	60
AHSV 2215M	22	15	60

THC - Throttle Hand valve Connector



PART NO.	Tube O.D.(mm)	Tube O.D.(mm)	Qty / Box
ATHC 1515M	15	15	20
ATHC 2222M	22	22	10

Check Valves

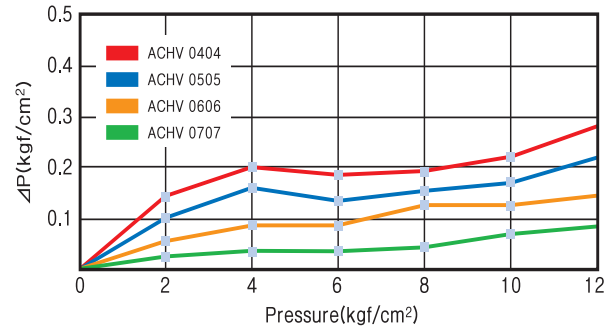

Features

- Can be used with a variety of chemicals and gases. However, when using other than water or air, please refer to Chemical Compatibility Tables, or consult our representative.
- Do not apply excessive vibration, shock, torque, or other strong loads on the fittings. The valve body may be damaged or the collets may be dislocated.
- Superior function in a compact size.
- Color : Inch Size - White Acetal Copolymer
Metric Size - Black Acetal Copolymer

Working Pressure and Temperature

Pressure	10bar	5bar
Temperature	1°C (35°F) ~ 20°C (70°F)	65°C (150°F)

Check Valve Sign

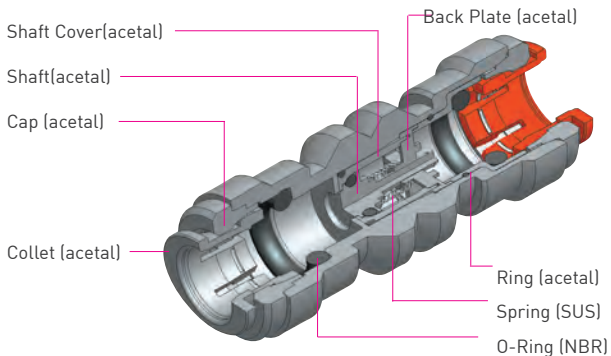
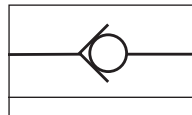

CHV - Check Valve



PART NO.	Outlet Tube O.D.	Inlet Tube O.D.	Qty / Box
ACHV 0404	1/4	1/4	300
ACHV 0405	1/4	5/16	250
ACHV 0505	5/16	5/16	250
ACHV 0606	3/8	3/8	200
ACHV 0707	1/2	1/2	150



PART NO.	Outlet Tube O.D.(mm)	Inlet Tube O.D.(mm)	Qty / Box
ACHV 0606M	6	6	250
ACHV 0808M	8	8	200
ACHV 1010M	10	10	200
ACHV 1212M	12	12	150

DCHV - Double Check Valve



PART NO.	Tube O.D.	Tube O.D.	Qty / Box
ADCHV 0404	1/4	1/4	200

DCHV - Double Check Valve



PART NO.	Tube O.D. (mm)	Tube O.D. (mm)	Qty / Box
ADCHV 1515M	15	15	50

MCHV - Mini Check Valve

NPTF Thread



PART NO.	Tube O.D.	NPTF Thread	Qty / Box
AMCHV 0402W	1/4	1/8	500

• 1kgf/cm² - 980cc/min

VALVES (GRAY / INCH)

Stop Valves



■ Features

- As a one touch fitting, it is often used where tubing facility is frequently changed.
- Stop fitting allows flow in both directions from the Check Valve in instances when they are connected with Tube. By disconnection the middle of valve, stopping the fluid in both sides, it maintains the faculties and the safe.
- Flows in both directions by connection.
- Stops flow in both directions by separation where pulling to the open position.
- Easy to assemble with the nut.

Working Pressure and Temperature

Pressure	10bar	5bar
Temperature	1°C (35°F) ~ 20°C (70°F)	65°C (150°F)

Stop Valve Sign

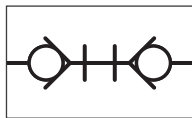

Structure

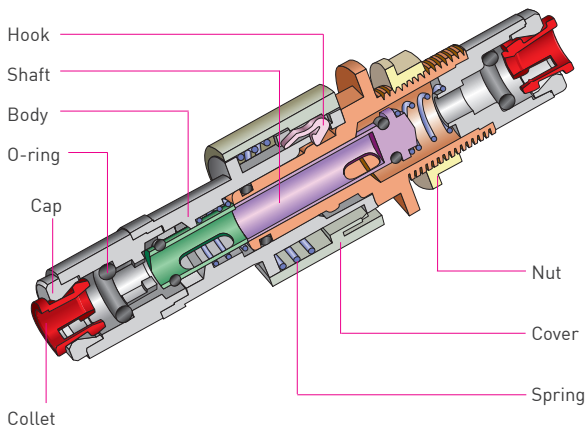

Flowing

■ Connector

- Flows in both directions by connection.

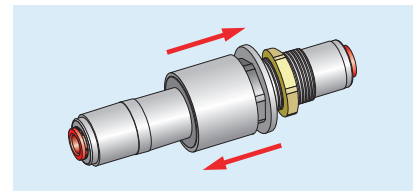

■ Disconnecter

- Stop flows in both directions by with separation where pulling to the open position.

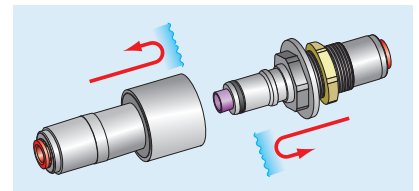

Assembly

- Just keep the direction marked on Body.

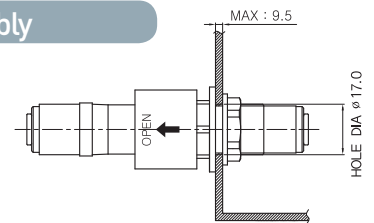

STVUC-Stop Valve Union Connector



PART NO.	Tube O.D.	Tube O.D.	Qty / Box
ASTVUC 0404	1/4	1/4	5

STVBUS-Stop Valve Bulkhead Union



PART NO.	Tube O.D.	Tube O.D.	Thread Size	Qty / Box
ASTVBUS 0404	1/4	1/4	M16XP1	5

STVBUE-Stop Valve Bulkhead Union Elbow



PART NO.	Tube O.D.	Tube O.D.	Thread Size	Qty / Box
ASTVBUE 0404	1/4	1/4	M16XP1	5

BSTMC-Stop Valve Male Connector



- Various sizes are available by the request of customers.
- Please contact the local representative office for more information.

FILTER STRAINERS



■ Features

- A rugged and durable filter strainer, available in 100 mesh (standard) with optional 150 or 200 mesh replaceable elements.
- **DMfit®** Compatible with DMfit tube and fittings, as well as standard-sized tubing from a variety of other manufacturers.
- Color options: gray, white, or black.
- The detachable CAP and BODY allow for easy servicing and cleaning.
- Can be used with a variety of chemicals and gases. However, when using with other than water or air, please refer to the Chemical Compatability Tables or consult our representative.
- Do not apply excessive vibration, torque, shock or other strong loads to the filter. The filter body may be damaged or collets may be dislocated.

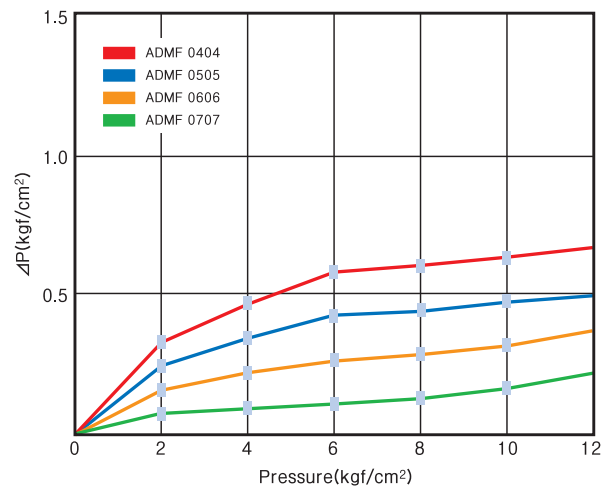
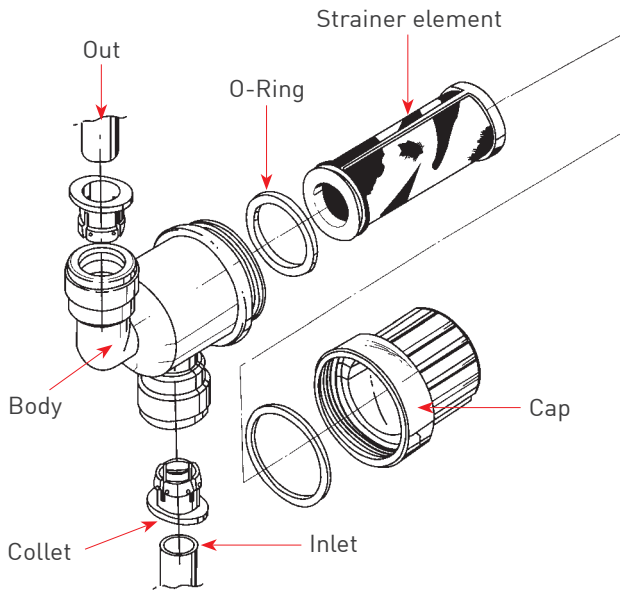

Working Pressure and Temperature

Parameter	Size	1/4"	5/16"	3/8"	1/2"
			6mm	8mm	10mm
Pressure		170psi			
Temperature		Air -20°C(-4°F) ~ 65°C(150°F) Liquid			

- ※ Maximum pressure values are based on use at room temperature.
- ※ Consult your DMT representative when using at continuous elevated temperature and pressure

Filter Materials and Mesh Size

Screen Mesh	Standard	Special Order
	100 Mesh	150 Mesh
Material	SUS	

- ※ Standard models are provided with 100 mesh screen elements.
- ※ Other meshes is available by special order.

Inch Size (Standard-100Mesh)



PART NO.	INLET	OUTLET	Qty / Box
ADMF 0404	1/4	1/4	50
ADMF 0505	5/16	5/16	50
ADMF 0606	3/8	3/8	50
ADMF 0707	1/2	1/2	40

Metric Size (Standard-100Mesh)



PART NO.	INLET	OUTLET	Qty / Box
ADMF 0606M	6	6	50
ADMF 0808M	8	8	50
ADMF 1010M	10	10	50
ADMF 1212M	12	12	40

BRASS FITTINGS



■ Suitable for

- With our one touch fittings for the hydraulic tube, it is possible to connect, disconnect and repair tubes quickly, more conveniently and safely.
- Since we have various sizes and functions the fittings can be applied to all tubes with wide scope of application.
- Our oval collets are specifically designed to conveniently remove tubes, but still provide a strong connection.
- The body was manufactured to have a hexagonal on the middle section to make more tightening as it can.
- Color : Body - Brass and Cr-plated
Collets - White

Working Pressure and Temperature

Pressure	12bar	6bar
Temperature	1°C(35°F) ~ 20°C(70°F)	65°C(150°F)

BUN - Brass Union



PART NO.	Tube O.D.	Tube O.D.	Qty / Box
BUN 0808	5/8	5/8	
BUN 1010	7/8	7/8	

PART NO.	Tube O.D. (mm)	Tube O.D. (mm)	Qty / Box
BUN 1515M	15	15	
BUN 1616M	16	16	
BUN 1818M	18	18	
BUN 2222M	22	22	

BFAB - Brass Female Adapter

BSP(P) Thread



PART NO.	Tube O.D.	BSP(P) Thread	Qty / Box
BFAB 0807	5/8	1/2	
BFAB 1009	7/8	3/4	
BFAB 1011	7/8	1	

PART NO.	Tube O.D. (mm)	BSP(P) Thread	Qty / Box
BFAB 1507M	15	1/2	
BFAB 1607M	16	1/2	
BFAB 2209M	22	3/4	
BFAB 2211M	22	1	

BFA - Brass Female Adapter

BSPT(PT) Thread



PART NO.	Tube O.D.	BSPT(PT) Thread	Qty / Box
BFA 0807	5/8	1/2	
BFA 1009	7/8	3/4	
BFA 1011	7/8	1	

PART NO.	Tube O.D. (mm)	BSPT(PT) Thread	Qty / Box
BFA 1507M	15	1/2	
BFA 1607M	16	1/2	
BFA 2209M	22	3/4	
BFA 2211M	22	1	

BMCB - Brass Male Connector

BSP(P) Thread



PART NO.	Stem O.D. (mm)	BSP(P) Thread	Qty / Box
BMCB 1007M	10	1/2	
BMCB 1207M	12	1/2	
BMCB 1509M	15	3/4	
BMCB 2209M	22	3/4	
BMCB 2211M	22	1	
BMCB 2811M	28	1	
BMCT 1207M	12	1/2	
BMCT 1507M	15	1/2	
BMCT 2209M	22	3/4	
BMCT 2811M	28	1	

BMSAB - Brass Male Stem Adapter

BSP(P) Thread



PART NO.	Stem O.D. (mm)	BSP(P) Thread	Qty / Box
BMISAB 1507M	15	1/2	
BMISAB 2209M	22	3/4	
BMSAB 1507M	15	1/2	
BMSAB 2209M	22	3/4	
BMSAB 2811M	28	1	
BFSAB 1507M	15	1/2	
BFSAB 2209M	22	3/4	
BMSAT 1507M	15	1/2	
BMSAT 2209M	22	3/4	
BMSAT 2811M	28	1	

BDC - Brass Drain Cock



PART NO.	Stem O.D. (mm)	Tube I.D. (mm)	Qty / Box
BDC 15M	15	13.8	

BFEB - Brass Flange Elbow

BSP(P) Thread



PART NO.	Tube O.D. (mm)	BSP(P) Thread	Qty / Box
BFEB 1507M	15	1/2	
BFEB 2209M	22	3/4	

CARTRIDGES



■ Half cartridges

- Half-cartridges are available in Acetal, Brass and Stainless Steel.
- They provide to simplify your application's size and shapes.
- In addition, they give you more cost effectiveness comparing to Fittings.
- Easy installation, Shorten time to assemble.
- Two O-rings make more completed sealing (Refer to Cavity Dimension).

AC - Acetal Cartridge



Inch size	PART NO.	Tube O.D.	Qty / Box
ACETAL CARTRIDGE O-RING NBR	ACU 01	5/32	2000
	ACU 03	3/16	2000
	ACP 04	1/4	1000
	ACP 05	5/16	1000
	ACP 06	3/8	700
	ACP 07	1/2	500

Metric size	PART NO.	Tube O.D. (mm)	Qty / Box
ACETAL CARTRIDGE O-RING NBR	ACU 04M	4	2000
	ACU 05M	5	2000
	ACP 06M	6	1000
	ACP 08M	8	1000
	ACP 10M	10	700
	ACP 12M	12	500

BC - Brass Cartridge



Inch size	PART NO.	Tube O.D.	Qty / Box
BRASS CARTRIDGE O-RING NBR	BC 01	5/32	2000
	BC 03	3/16	2000
	BC 04	1/4	1000
	BC 05	5/16	1000
	BC 06	3/8	700
	BC 07	1/2	500

Metric size	PART NO.	Tube O.D. (mm)	Qty / Box
BRASS CARTRIDGE O-RING NBR	BC 04M	4	2000
	BC 05M	5	1000
	BC 06M	6	1000
	BC 08M	8	1000
	BC 10M	10	700
	BC 12M	12	500
	BC 15M	15	500
	BC 22M	22	300

SC - Stainless Steel Cartridge

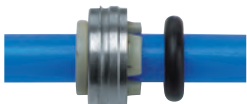

Inch size	PART NO.	Tube O.D.	Qty / Box
STAINLESS STEEL CARTRIDGE O-RING NBR	SC 01	5/32	2000
	SC 03	3/16	2000
	SC 04	1/4	1000
	SC 05	5/16	1000
	SC 06	3/8	700
	SC 07	1/2	500

Metric size	PART NO.	Tube O.D. (mm)	Qty / Box
STAINLESS STEEL CARTRIDGE O-RING NBR	SC 04M	4	2000
	SC 05M	5	1000
	SC 06M	6	1000
	SC 08M	8	1000
	SC 10M	10	700
	SC 12M	12	500
	SC 15M	15	500
	SC 22M	22	300

CARTRIDGES

Cavity Dimension

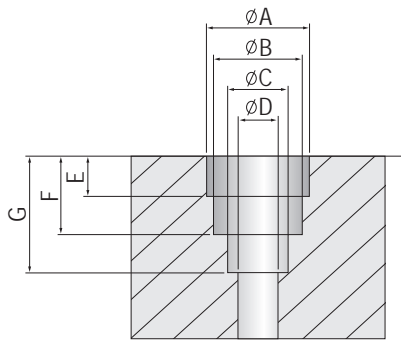

Assembly

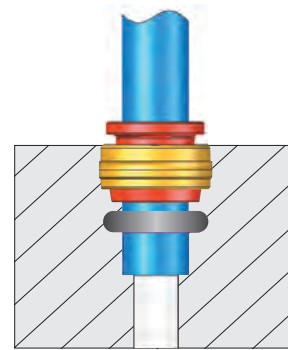

Inch Sizes

(Unit: inch)

Size (Inch)	$\phi A \pm 0.002''$	$\phi B \pm 0.002''$	$\phi C \pm 0.002''$	$\phi D \pm 0.002''$	$\phi E \pm 0.01''/-0$	$\phi F1 \pm 0.006''$	$\phi F2 \pm 0.006''$	$\phi G1 \pm 0.006''$	$\phi G2 \pm 0.006''$
5/32	0.490	0.317	0.161	0.098	0.181	0.370	0.462	0.502	0.594
3/16	0.470	0.344	0.197	0.126	0.181	0.370	0.462	0.502	0.594
1/4	0.528	0.421	0.257	0.169	0.181	0.373	0.477	0.545	0.653
5/16	0.542	0.465	0.323	0.217	0.213	0.413	0.508	0.615	0.709
3/8	0.630	0.563	0.382	0.250	0.268	0.472	0.574	0.719	0.822
1/2	0.775	0.661	0.508	0.374	0.303	0.525	0.629	0.827	0.945

Metric Sizes

(Unit: mm)

Size (mm)	$\phi A \pm 0.05$	$\phi B \pm 0.05$	$\phi C \pm 0.05$	$\phi D \pm 0.05$	$\phi E \pm 0.25/-0$	$\phi F1 \pm 0.15$	$\phi F2 \pm 0.15$	$\phi G1 \pm 0.15$	$\phi G2 \pm 0.15$
4	12.44	8.05	4.20	2.50	4.59	9.39	11.73	12.75	15.08
5	11.93	8.73	5.20	3.50	4.59	9.39	11.73	12.75	15.08
6	13.41	10.69	6.20	4.00	4.59	9.47	12.22	13.84	16.59
8	13.76	11.81	8.20	6.00	5.41	10.50	12.90	15.63	18.00
10	16.00	14.30	10.20	7.00	6.80	11.98	14.28	18.27	20.87
12	19.68	16.78	12.20	9.00	7.69	13.33	16.27	21.00	24.00
15	22.90	20.20	15.20	12.00	9.00	17.20	20.00	26.30	26.30
22	31.05	27.60	22.20	19.20	10.90	21.10	24.30	31.30	31.30

※ Double O-rings half cartridges : Columns F2 and G2

Structure

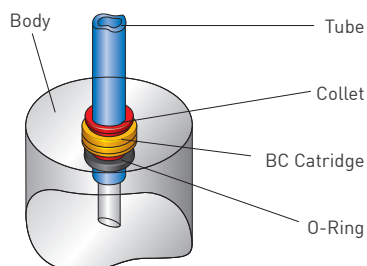

How to assemble

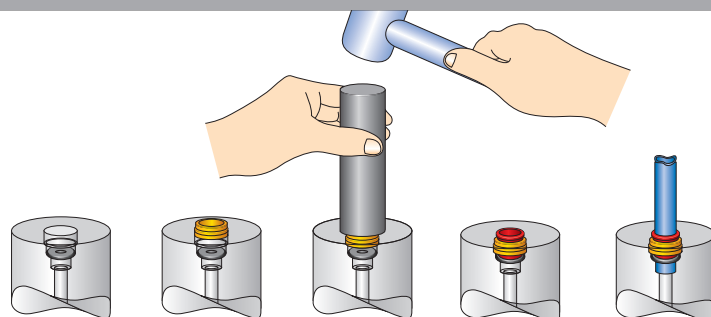

- Caution
- Tap softly with special tool standing for inserting cartridge into the Cavity. (Use the tool with flat base if you don't have any special tool for an insert cartridges)
- Please check up the breakaway a cartridge from the Cavity with pulling gently the tube inserted.

FULL CARTRIDGES

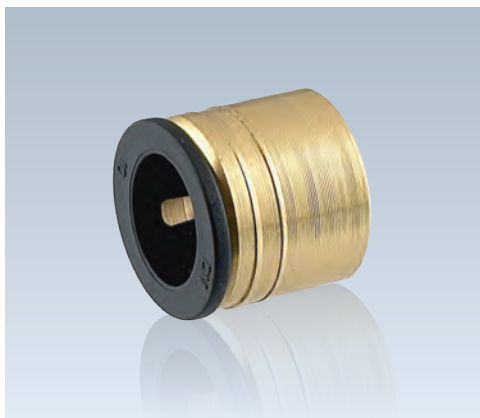

■ Features

DM full cartridges are designed to provide a saving cost and effective way to connect tubes perfectly into metallic products.

The cartridge is supplied with NBR O-ring and collet.

The cartridge are good for compressed air applications.

Please do check if your application is required an additional bonding on.

Please do refer to our plastic cartridges shown on pages 45 to 46 of this catalogue if you need to install connections into plastic products.

■ Cavity Dimensions

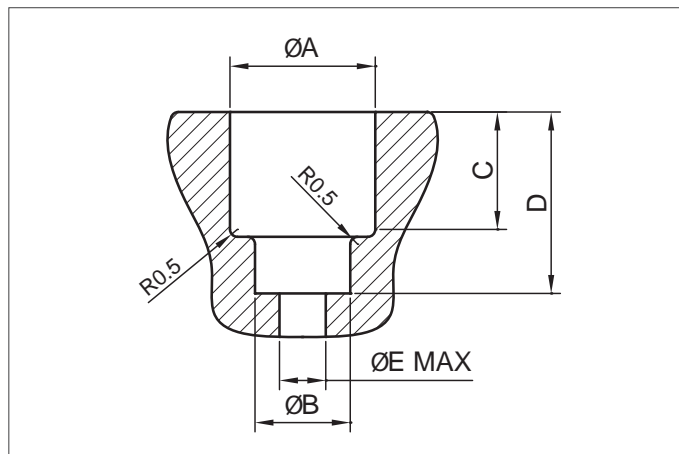
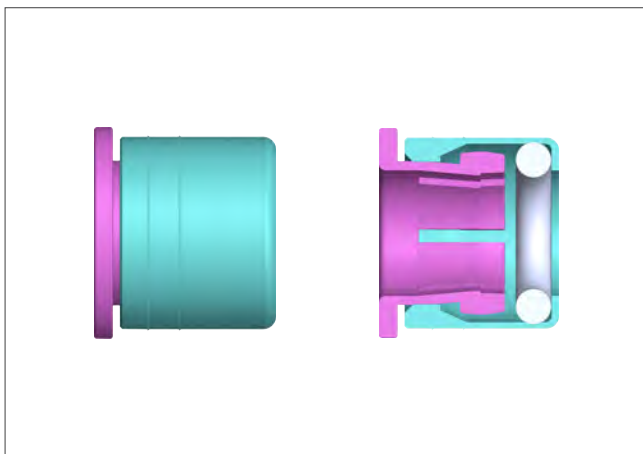

Metric Sizes



PART NO.	Size(mm)	$\phi A \pm 0.05$	$\phi B \pm 0.05$	$\phi C \pm 0.25$	$D \pm 0.15$	$\phi E \text{ MAX}$
FC04M	04	9.12	4.20	9.30	12.65	2.75
FC05M	05	9.82	5.20	9.90	13.25	3.50
FC06M	06	11.78	6.20	11.30	15.67	4.00
FC08M	08	12.88	8.20	11.05	16.18	6.00
FC10M	10	15.38	10.20	12.40	18.69	7.00
FC12M	12	17.88	12.20	13.80	21.47	9.00

※ All dimensions in Metric.

ACCESSORIES

TS - Tube Support



PART NO.	Tube O.D.	Tube I.D.	Qty / Box
ATS 04	1/4	0.170	3,500
ATS 05	5/16	0.216	3,000
ATS 06	3/8	1/4	1,500
ATS 07	1/2	0.350	800
ATS 08	5/8	0.476	600
ATS 10	7/8	0.669	500

PART NO.	Tube O.D. (mm)	Tube I.D. (mm)	Qty / Box
ATS 06M	6	4	3,500
ATS 08M	8	6	3,000
ATS 10M	10	7	1,600
ATS 12M	12	9	800
ATS 15M	15	11.4	600
ATS 16M	16	12	600
ATS 18M	18	14	400
ATS 22M	22	17.6	500
ATS 28M	28	23	300

- The tube support is recommended for use with soft or very thin walled tubing.

DSI - Double Seal Insert



PART NO.	Tube O.D.	Tube I.D.	Qty / Box
ADSI 06	3/8	1/4	2,000
ADSI 07	1/2	0.332	1,000
ADSI 08	5/8	0.472	800
ADSI 10	7/8	0.669	600

PART NO.	Tube O.D. (mm)	Tube I.D. (mm)	Qty / Box
ADSI 08M	8	6	3,000
ADSI 10M	10	7	2,000
ADSI 12M	12	9	1,000
ADSI 15M	15	11.5	600
ADSI 16M	16	12	800
ADSI 18M	18	14	600
ADSI 22M	22	17.5	600
ADSI 28M	28	23	400

COV - Collet COVER



PART NO.	Tube O.D.	Qty / Box
ACOV 04	1/4	700
ACOV 05	5/16	600
ACOV 06	3/8	600
ACOV 07	1/2	500
ACOV 08	5/8	500
ACOV 10	7/8	300

PART NO.	Tube O.D. (mm)	Qty / Box
ACOV 06M	6	700
ACOV 08M	8	600
ACOV 10M	10	600
ACOV 12M	12	500
ACOV 15M	15	500
ACOV 16M	16	500
ACOV 18M	18	400
ACOV 22M	22	300
ACOV 28M	28	200

LC - Locking Clip



PART NO.	Tube O.D.	Qty / Box
ALC 03	3/16	12,000
ALC 04	1/4	10,000
ALC 05	5/16	8,000
ALC 06	3/8	7,000
ALC 07	1/2	5,000
ALC 08	5/8	2,500
ALC 10	7/8	2,000

PART NO.	Tube O.D. (mm)	Qty / Box
ALC 05M	5	12,000
ALC 06M	6	10,000
ALC 08M	8	8,000
ALC 10M	10	7,000
ALC 12M	12	5,000
ALC 15M	15	4,000
ALC 16M	16	4,000
ALC 18M	18	3,000
ALC 22M	22	2,000
ALC 28M	28	2,000



FBC - Flow Bend Clip

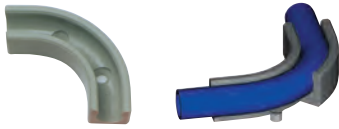

PART NO.	Tube O.D.	Qty / Box
AFBC 05	5/16	300
AFBC 06	3/8	200
AFBC 07	1/2	150

PART NO.	Tube O.D. (mm)	Qty / Box
AFBC 06M	6	400
AFBC 08M	8	300
AFBC 10M	10	200
AFBC 12M	12	150



PART NO.	Tube O.D.	Qty / Box
NFBC 08	1/2(12mm) to 5/8(15mm)	100

- FBC 08 is made from Nylon 66.
- Provides a simple method for smooth 90 degree tube bend without twist.
- Can be built into the equipment or walls with screws.

SP - Spanner



PART NO.	Tube O.D.
ASP	3/16, 1/4, 5/16, 3/8, 1/2

HTC - Hand Tube Cutter

(Nylon)



PART NO.	Tube O.D. (Minimum)	Tube O.D. (Maximum)
NHTC 08	5/32(4mm)	5/8 (16mm)

PSP - Power Spanner

(Nylon)



PART NO.	Tube O.D.
NPSP	5/16, 3/8

- Available in metallic spanner

TC - Tube Cutter



PART NO.	Tube O.D.	Qty / Box
TC	MAX. DIA 1/2" or 13mm	40

- DMfit® Tube Cutter with quality blade is suitable for cutting plastic tubing sizes up to 13mm.

Hook



PART NO.	Size (mm)	Qty / Box
AHOOK	19.5	

TLC - Tube Locking Clamp

(Nylon)



PART NO.	Tube O.D.	Qty / Box
NTLC 08	5/8(16mm)	200

RA - Release Aid



PART NO.	Tube O.D.	Qty / Box
ARA 06	3/8	700
ARA 07	1/2	700
ARA 08	5/8	600
ARA 10	7/8	500

PART NO.	Tube O.D. (mm)	Qty / Box
ARA 10M	10	700
ARA 12M	12	700
ARA 12M	12	600
ARA 15M	15	600
ARA 16M	16	600
ARA 18M	18	500
ARA 22M	22	500
ARA 28M	28	500

EFCAP - Easy Fitting CAP



PART NO.	Tube O.D.	Qty / Box
AEFCAP 04	1/4	1000

- Fittings need to be separated from the Tank and The Filter, Especially under the pressure It can offer a solution : EASY and Quick Separation by Using The Cap.

• FITTING + TUBE

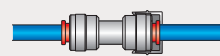

• FITTING + STEM FITTING

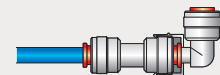

• FITTING + FILTER

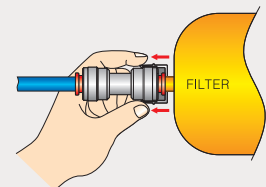

LLDPE TUBES



DMfit® tubing is produced from an advanced grade of low density polyethylene. Its greatest advantage is superior environmental stress cracking resistance (ESCR), greatly exceeding that of ordinary polyethylene tubing as measured by ASTM D-1693 (IGEPAL) tests. Environmental stresses that can shorten the service life of tubing include chemical exposure, aging connections with barb-type fittings, or high vibration loads with connections to compression fittings. Our tubing is compliant to ANSI/NSF-51, 61, WRAS and FDA requirements for food contact applications. Our tubing is available in multiple coding colors, and offers the user :

- Dimensional stability
- Higher burst pressure
- Wide range of available colors.
- Suitable for use with **DMfit®** products and those of other manufacturers.
- Uniformity and long-term strength
- Greater tensile strength

Working Pressure and Temperature

Parameter	Size	5/32"	3/16"	1/4"	5/16"	3/8"	1/2"
		4mm	5mm	6mm	8mm	10mm	12mm
Pressure		230 psi			170 psi		
Tube Tolerances		-0.1mm / +0.1mm					
Temperature	Air	-20°C(-4°F) ~ 65°C(150°F)					
	Liquid						

- * Pressure values are based on PE tube used at room temperature.
- * Consult our representative when using at continuous elevated temperature and pressure.

Order Information

DPE 04 (M) - B - 0500

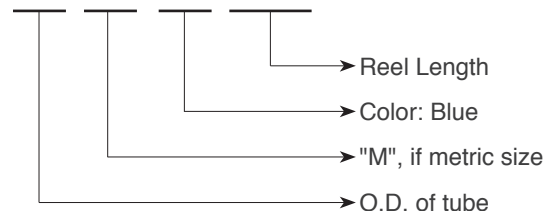

Colors Available

Suffix	Color	LLDPE											PE-RT			
		5/32"	3/16"	1/4"	5/16"	3/8"	1/2"	4mm	5mm	6mm	8mm	10mm	12mm	15mm	1/4"	5/16"
B	Blue	○	○	○	○	○	○	○	○	○	○	○	○	○	○	○
Y	Yellow	○	○	○	○	○	○	○	○	○	○	○	○	○		
W	White	○	○	○	○	○	○	○	○	○	○	○	○	○	○	○
N	Natural	○	○	○	○	○	○	○	○	○	○	○	○	○	○	○
BK	Black	○	○	○	○	○	○	○	○	○	○	○	○			
R	Red	○	○	○	○	○	○	○	○	○	○	○	○			
GR	Gray	○	○	○	○	○	○	○	○	○	○	○	○			
G	Green	○	○	○	○	○	○	○	○	○	○	○	○			

TC - Tube Cutter

- **DMfit®** Tube Cutter with quality blade is suitable for cutting plastic tubing sizes up to 13mm.



Inch Size

Part No.	Material	O.D.In.	I.D. In.	Wall	Reel Length (Meter)
DPE 01	LLDPE	5/32"	0.094	0.031	500
DPE 03	LLDPE	3/16"	0.125	0.031	400
DPE 04	LLDPE	1/4"	0.17	0.04	300
DPE-RT 04	PE-RT	1/4"	0.17	0.04	300
DPE 05	LLDPE	5/16"	0.216	0.048	200
DPE-RT 05	PE-RT	5/16"	0.216	0.048	200
DPE 06	LLDPE	3/8"	1/4"	0.062	150
DPE 07	LLDPE	1/2"	3/8"	0.062	100

Metric Size

Part No	Material	O.D.In.	I.D. In.	Wall	Reel Length (Meter)
DPE 04M	LLDPE	4	2.5	0.75	500
DPE 05M	LLDPE	5	3.5	0.75	400
DPE 06M	LLDPE	6	4	1	300
DPE 08M	LLDPE	8	6	1	200
DPE 10M	LLDPE	10	7	1.5	150
DPE 12M	LLDPE	12	9	1.5	100
DPE 12M	LLDPE	12	9	1.5	100
DPE 15M	LLDPE	15	11.5	1.75	70

CHEMICAL COMPATABILITY TABLES

DMfit® has excellent resistance to exposure to organic compounds, industrial chemicals, and gases.

■ Resistance of chemical characteristics for plastic resins & elastomers.

Description (% , °C)	Brass	SUS	Resin		Rubber		Description (% , °C)	Brass	SUS	Resin		Rubber	
			Acetal	PP	NBR	EPDM				Acetal	PP	NBR	EPDM
Caustic soda(10%, 20°C)	△	△	◎	○	○	◎	Lye solution	-	-	◎	○	○	◎
Gasoline	○	○	◎	△	◎	×	Hydrochloric acid(10%, 20°C)	×	×	○	◎	-	-
Formic acid(25%, 20°C)	×	△	×	◎	○	◎	Hydrochloric acid(20%, 20°C)	×	×	△	○	-	-
Air	◎	◎	◎	◎	◎	◎	Hydrochloric acid(20%, 80°C)	×	×	×	×	×	△
Mineral oil	○	○	◎	○	◎	×	Hydrochloric acid(38%, 20°C)	×	×	△	○	○	◎
Grease	○	◎	◎	△	◎	×	Ammonium chloride	×	△	○	◎	◎	◎
Sodium silicate	○	-	◎	◎	◎	◎	Calcium chloride	○	△	◎	◎	◎	◎
Glycerin	○	◎	◎	◎	◎	◎	Naphtha	△	○	◎	△	△	×
Ozone	○	○	△	△	○	◎	Olive oil	△	◎	○	◎	◎	○
Animal oil(Lard oil)	○	-	◎	○	◎	○	Sulfur	×	○	◎	◎	×	◎
Kerosene	◎	◎	◎	◎	◎	×	Sodium phosphate	×	△	○	◎	◎	◎
Methane	○	-	◎	◎	◎	×	Ammonium phosphate	△	△	○	◎	◎	◎
Methyl alcohol(Methanol)	◎	△	○	○	◎	◎	Ammonium nitric	×	○	○	◎	◎	◎
Water(24°C)	○	○	◎	◎	◎	◎	Nitrogen	○	◎	◎	◎	◎	◎
Water(100°C)	×	○	△	△	-	-	Natural gas	◎	◎	◎	○	◎	×
Sea water	△	○	◎	◎	-	-	Acetic acid(10%, 20°C)	-	-	-	-	-	-
Bunker oil	△	-	-	○	◎	-	Acetic acid(50%, 20°C)	-	-	-	-	-	-
Benzene(Benzol)	×	△	○	△	×	×	Acetic acid(50%, 70°C)	-	-	-	-	-	-
Butane	◎	◎	◎	◎	◎	×	Acetic acid(100%, 20°C)	-	-	-	-	-	-
Fluorine	×	×	×	×	-	△	Ketones	○	○	○	◎	-	○
Boric acid	○	○	○	◎	◎	◎	Cresol	○	△	△	○	△	×
Carbon tetrachloride	△	△	○	△	△	×	Chromic acid(2%, 70°C)	×	×	×	△	-	-
Oxygen	◎	◎	○	○	○	◎	Chromic acid(10%, 70°C)	×	×	×	×	-	-
Petroleum	-	-	○	×	◎	×	Chromic acid(25%, 70°C)	×	×	×	×	-	-
Soda ash(Sodium carbonate)	○	△	◎	◎	◎	◎	Chromic acid(2%, 50°C)	×	×	△	△	×	○
Calcium hydroxide	△	△	◎	○	◎	◎	Soybean oil	△	○	◎	○	◎	△
Hydrogen	△	◎	◎	◎	◎	◎	Toluene	◎	◎	○	△	×	×
Mercury	×	-	-	◎	◎	◎	Glucose	◎	◎	◎	◎	◎	◎
Steam(150°C)	○	-	△	×	×	◎	Propane	◎	◎	◎	◎	◎	×
Sodium cyanide	×	-	-	-	◎	◎	Castor oil	○	○	○	◎	◎	○
Vegetable oil	-	-	○	○	◎	◎	Sulfuric acid(10%, 20°C)	×	×	○	○	×	○
Silicone greases	-	-	◎	△	◎	◎	Sulfuric acid(10%, 70°C)	×	×	×	△	-	-
Silicone oil	-	-	◎	△	◎	◎	Sulfuric acid(30%, 20°C)	×	×	△	○	-	-
Acetone	◎	△	○	△	×	◎	Sulfuric acid(30%, 70°C)	×	×	×	△	-	-
Sulfurous acid gas	-	-	△	○	○	○	Sulfuric acid(98%, 20°C)	×	×	×	×	-	-
Ammonia	△	◎	○	○	◎	◎	Aluminium sulfate	×	○	○	◎	◎	◎
Liquefied petroleum gas(LPG)	◎	◎	◎	○	◎	×	Potassium sulfate	○	△	○	◎	◎	◎
Ethyl alcohol(Ethanol)	◎	○	◎	○	◎	◎	Hydrogen sulfide	△	△	○	◎	×	◎

※ ◎ : Very acceptable ○ : Acceptable △ : Slightly Unacceptable × : Unacceptable - : No data

■ Resistance of chemical characteristics for Tube.

Name of chemical	Polyethylene	Remarks	Name of chemicals	Polyethylene	Remarks
Air	◎		Hexane	△	
Alcohol	◎		Hydrogen gas	◎	
Ammonia gas	◎		Lighting gas	△	
Ammonia liquid	○	high temperature △	Mercury	◎	
Beer	◎		Methanol (Methyl Alcohol)	◎	
Benzene	△		Milk	◎	
Bromine liquid	×		Molasses	◎	
Carbon dioxide gas	○		Nickel salts	◎	
Caustic soda	○		Oils, essential	△	
Diesel fuel	△		Propane gas	△	
Ethyl alcohol	○	high temperature △	Spindle Oil	△	
Fluor gas, dry	×		Water, high-purity	◎	
Fuel Oil	△				

※ : Very acceptable, ○ : Acceptable, △ : Slightly unacceptable, × : Very unacceptable
 ※ Differences in data can exist due to extended duration and elevated temperature (Standard data reflects use at ambient temperature.)
 ※ Consult our representative when using unsuitable liquids.

GLOBAL SALES



Head Office & Factory

143B-3L 27, Namdongdong-ro, 77beon-gil, Namdong-gu, Incheon, KOREA

TEL : +82-32-812-7311~3 FAX : +82-32-812-7314

www.dmfite.com, global@dmfite.com